



International Patent Public No.:  
WO 2006/007772  
China Patent No.: ZL02220153.X,  
ZL200420062895.3  
US Patent No.: 7549446  
India Patent No.: 232582  
Russia Patent No.:2349819  
South Korea Patent No.:10-0914137  
Mexico Patent No.: 268581  
Australia Patent No.: 2005263257  
Philippine Patent No.: 1-2006-502553  
Taiwan Patent No.:M287896

## Multi-functional Flow Control Valve for Water Treatment Systems

51215 (Old Model No.: F77BS)

61215 (Old Model No.: F77AS)

91215 (Old Model No.: F77CS)

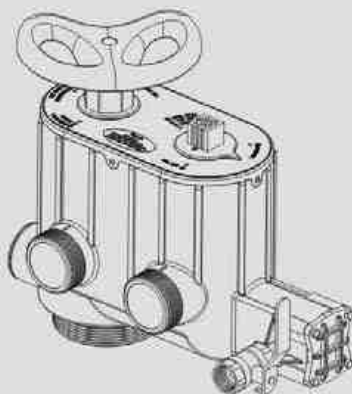

## Instruction Manual



Please read this manual in details  
before using this valve and keep it properly  
In order to consult in the future  
0WRX.466.506

MODEL: F77BS-51215/F77AS-61215/F77CS-91215

Before the valve put into use, please fill in the below content so as to help us to refer in the future.

**Softener System Configuration**

Tank Size: Dia. \_\_\_\_\_ mm, Height \_\_\_\_\_ mm;

Resin Volume \_\_\_\_\_ L; Brine Tank Capacity \_\_\_\_\_ L;

Hardness of Raw Water \_\_\_\_\_ mmol/L;

Pressure of Inlet Water \_\_\_\_\_ MPa;

Control Valve Model \_\_\_\_\_ ; Number \_\_\_\_\_ ;

Water Source: Ground-Water  Filtered Ground-water  Tap Water  Other \_\_\_\_\_  
\_\_\_\_\_.

**Parameter**

Backwash \_\_\_\_\_ min.; Brine & Slow Rinse Time \_\_\_\_\_ min.;

Brine Refill Time \_\_\_\_\_ min.; Fast Rinse Time \_\_\_\_\_ min.;

The Specification of Drain Line Flow Control \_\_\_\_\_ ;

Injector No. \_\_\_\_\_ .

If there is no special requirement when product purchase, we choose 3# injector for the standard configuration.

## Catalogue

Notice.....	3
1.Product Overview.....	4
1.1. Main Application & Applicability.....	4
1.2. Product Characteristics.....	4
1.3. Service Condition.....	4
1.4. Product Structure and Technical Parameters.....	6
1.5. Installation.....	7
2. Usage.....	10
2.1.Hand Wheel.....	10
2.2. Indicator.....	11
2.3. Figure on Decoration Cover and its English Description.....	13
3.Application.....	14
3.1.Working Flow Chart.....	14
3.2. System Configuration and Flow Rate Curve.....	16
3.3. Parameter Settlement.....	18
3.4. Trial Running.....	18
3.5.Base Usage.....	20
3.6. Trouble-Shooting.....	20
3.7. Spare Part and Part No.....	21
4.Warranty Card.....	25

## Notice

- To ensure normal operation of the valve, please consult with professional installation or repairing personnel before use it.
- If there are any of pipeline engineering and electric works, there must be finished by professional at the time of installation.
- Do not use the control valve with the water that is unsafe or unknown quality.
- Depending on the changing of working environment and water requirement, each parameter of softener should be adjusted accordingly.
- When the water treatment capacity is too low, please check the resin. If the reason is shortage of resin, please add; if the resin is turn to reddish brown or broken, please replace.
- Test water periodically to verify that system is performing satisfactorily.
- During softener process, sodium is regarded as a part of edible salt. If you are sodium limited intake person, please contact doctor.
- Sodium used in the water softening process should be considered as part your overall dietary salt intake. Contact doctor if you are on a low sodium diet.
- Do not put the valve near the hot resource and do not leave it outside.
- Forbidden to use the brine tube or other connectors as support to carry the system.
- Please use this product under the water temperature between 5 ~ 50°C, water pressure 0.2 ~ 0.6MPa. Failure to use this product under such conditions voids the warranty.
- If the water pressure exceeds 0.6Mpa, a pressure reducing valve must be installed before the water inlet. While, if the water pressure under 0.2MPa, a booster pump must be installed before the water inlet.
- Do not let children touch or play, because carelessness operating may cause the procedure changed.
- We advise you to use M88 × 2 distributors. It is easy for disassembly.

## 1. Product Overview

### 1.1. Main Application & Applicability

Used for softening、demineralization or filtration water treatment systems

F77AS (DF for regeneration), suitable for

Ion exchange equipment, the raw water hardness  $\leq 6.5\text{mmol/L}$ .

Boiler softening water system

RO pretreatment softening system, etc.

F77BS(Filtration), suitable for swimming pool filter system.

Filtration system

Activated carbon filter or sand filter of RO pretreatment system.

F77CS(Floating bed) Ion exchange equipment, the raw water hardness  $< 15\text{mmol/L}$ .

(When it used as UF regeneration in boiler softening water system, the raw water hardness  $\leq 6.5\text{mmol/L}$ )

Boiler softening water system

RO pretreatment softening system, etc.

### 1.2. Product Characteristics

#### ➤ Simple structure and reliable sealing

It adopts hermetic head faces with high degree pottery and corrosion resistance for opening and closing. It has two valve cores. One controls inlet water, the other controls outlet water.

#### ➤ No water pass the valve in regeneration in single tank type.

#### ➤ Brine refill controlled by manual ball valve. (F77AS/61215, F77CS/91215)

During service, manual ball valve will control to start the brine refill, in order to shorten the regeneration cycle time.

#### ➤ Two ways for installation

Use side-mounted connector to change the valve from top-mounted to side-mounted.

F77CS can be installed in top mounted or side mounted. (When side-mounted connector TOP side connected with top strainer, BOTTOM side connected with side bottom strainer)

It's up-flow for regeneration. If connector with side-mounted in upside down (TOP side connector with bottom strainer, BOTTOM side connected with top strainer) It's for floating bed system.

## MODEL: F77BS-51215/F77AS-61215/F77CS-91215

### ►For filtration system

Drain outlet is the same size as water outlet. Block the brine line connector change the valve to F77BS filter valve.

### 1.3. Service Condition

Runxin Valve should be used under the below conditions:

Items		Requirement
Working conditions	Water pressure	0.2MPa ~ 0.6MPa
	Water temperature	5°C ~ 50°C
Working environment	Environment temperature	5°C ~ 50°C
	Relative humidity	≤95% (25°C)
Inlet water quality	Water turbidity	Softener(F77AS,F77CS)<2FTU; Filter(F77BS)<20FTU
	Water hardness	First Grade Na <sup>+</sup> <6.5mmol/L; Second Grade Na <sup>+</sup> <10mmol/L Floating bed (F77CS) <15mmol/L
	Free chlorine	<0.1mg/L
	Iron <sup>2+</sup>	<0.3mg/L
	CODMn	<2mg/L (O <sub>2</sub> )

In the above table, First Grade Na<sup>+</sup> represents First Grade Na<sup>+</sup> Exchanger. Second Grade Na<sup>+</sup> represents Second Grade Na<sup>+</sup> Exchanger.

● When the water turbidity exceeds the conditions, a filter should be installed on the inlet of control valve.

● When the water hardness exceeds the conditions, the outlet water hardness will hardly reach the requirement of boiler feed water (0.03 mmol/L). It is suggested to adopt second grade softener.

## MODEL: F77BS-51215/F77AS-61215/F77CS-91215

### 1.4. Product Structure and Technical Parameters

A. Product dimension (The appearance is just for reference. It is subjected to the real product.)

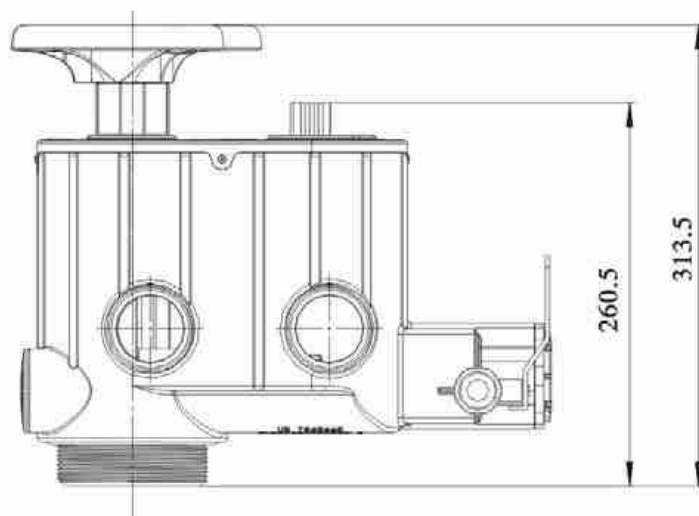
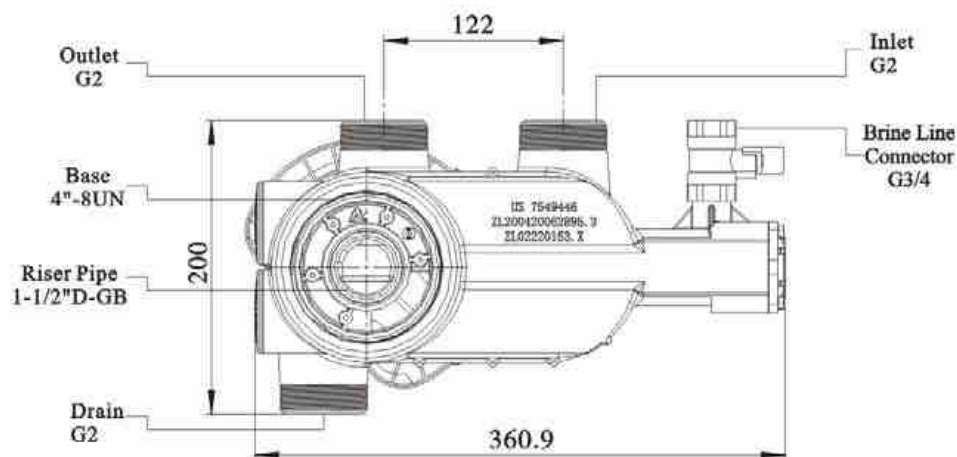

F77AS has the same appearance as F77CS. Block the drain line connector, it will become F77BS.

## MODEL: F77BS-51215/F77AS-61215/F77CS-91215

### B. Technical Parameter

Model	Connector Size					Flow Rate m <sup>3</sup> /h@ 0.3MPa	Remark
	In/ Outlet	Drain Outlet	Brine Line Connector	Base	Riser Pipe		
F77AS 61215	2" M	2" M	3/4" M	4"-8UN	1.5"D-GB(50mm)	15	DF
F77BS 51215	2" M	2" M	/	4"-8UN	1.5"D-GB(50mm)	15	Filter
F77CS 91215	2" M	2" M	3/4" M	4"-8UN	1.5"D-GB(50mm)	15	UF floating bed

Remark: M-Male F-Female OD-Outer Diameters, 1.05OD=26.7mm

Above flow rate is the maximum flow rate which tested under pressure drop 0.3MPa. F77CS can be used as floating bed. But at the same time it only can be side-mounted with the connector in upside down.( TOP side connector with bottom strainer, BOTTOM side connected with top strainer)

### 1.5. Installation

#### A. Installation notice

Before installation, read all those instructions completely. Then obtain all materials and tools needed for installation.

The installation of product, pipes and circuits, should be accomplished by professional to ensure the product can operate normally.

Perform installation according to the relative pipeline regulations and the specification of Water Inlet, Water Outlet, Drain Outlet, and Brine Line Connector.

#### B. Device location

- ①The softener should be located close to drain.
- ②Ensure the unit is installed in enough space for operating and maintenance.
- ③Brine tank need to be close to softener.
- ④The unit should be kept away the heater, and not be exposed outdoor. Sunshine or rain will cause the system damage.
- ⑤Please avoid to install the system in Acid/Alkaline, Magnetic or strong vibration circumstance, because above factors will cause the system disorder.
- ⑥Do not install the filter or softener, drain pipeline in circumstance which temperature may drop below 5°C, or above 50°C.
- ⑦One place is recommended to install the system which cause the minimum loss in case of water leaking

C. Pipeline installation(Take F77AS side-mounted as a sample)



## MODEL: F77BS-51215/F77AS-61215/F77CS-91215

### ①Install control valve

- As the Figure 1-1 shows , glue the riser pipe to the bottom strainer and put it into the mineral tank.
- Fill the mineral to the tank, and the height is accordance with the design code. Install the top distributor to the valve.
- Use DN50 UPVC pipe to connect side-mounted connector with top and bottom strainers. (TOP side connector with top strainer, BOTTOM side connected with bottom strainer)
- Connect valve with side-mounted connector. Use steel fork to adjust position of the valve, which makes the inlet/outlet pipe line straight to up or down.

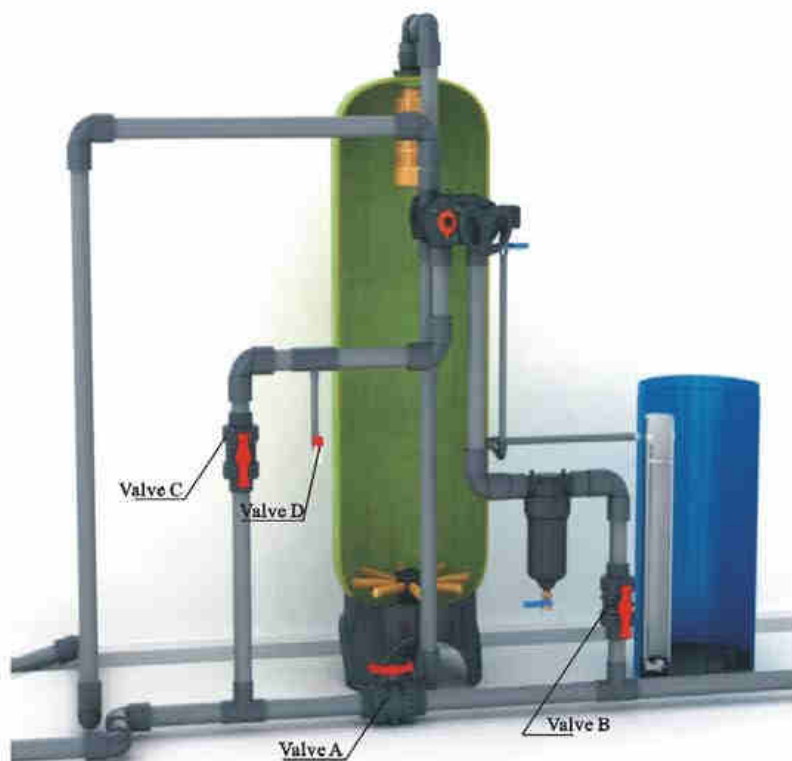

Figure1-1



- Avoid floccules substance together with resin to fill in the mineral tank.
- Avoid O-ring inside control valve falling out while rotating it on the tank.

### ②Pipeline connection

- As Figure1-2 shows, install a disc filter in the inlet.

## MODEL: F77BS-51215/F77AS-61215/F77CS-91215

- a. Install sampling valves in inlet, outlet and pipeline A.B.C. as showed in Figure 1-1.
- b. Use DN50 UPVC for system inlet pipe line and valve inlet. Put the flow meter in the valve outlet. Use DN50 UPVC connector system outlet with flow meter.



- If use welded copper pipe for inlet/outlet pipeline, the pipeline should be welded first. Then connect to valves. The high temperature will make the plastic pipe broken.
- Don't use too much strength to screw the pipe line. Keep the pipe line in right place to connect with valve.
- During installation, keep the inlet/outlet pipeline in parallel. And pipeline should be fixed.

- ③ Install drain pipeline (If no special requirement, the standard DLFC is No.7703)
  - a. Based on the table P17, for F77AS, if tank diameter is 900mm, use the matched DLFC. If the tank size bigger then 900mm, you need to ask supplier for another DLFC which doesn't drill hole. Install it as below steps.
  - b. According to matched tank diameter size, to drill  $\phi 6$  hole on the corresponding quantity of DLFC.
  - c. Insert drain line flow control into drain hose connector, then crew it into drain outlet, and lock it.
  - d. Glue the drain outlet with UPVC (DN40). Put drain outlet pipe to sewer as showed in the Figure 1-2.



Figure 1-2

## MODEL: F77BS-51215/F77AS-61215/F77CS-91215

e. For filter valve F77B, there is no DLFC, install UPVC (DN40) according to procedure d.



- Control valve should be higher than drain outlet, and be better not far from the drain hose.
- Be sure not connect drain with sewer, and leave a certain space between them, avoid wastewater be absorbing to the water treatment equipment, such as showed in the Figure1-2.

### ④Connect brine tube

As Figure1-2 shows, use UPVC (DN20) to connect brine valve with brine line connector.



- Keep brine line short and smooth. Elbow no more than four to avoid bad brine.
- Brine valve must be installed.

## 2.Usage

### 2.1. Hand wheel

As Figure shows, the valve needs one hand wheel to operate two indicators in anticlockwise, which to realize backwash, brine & slow rinse or fast rinse functions.

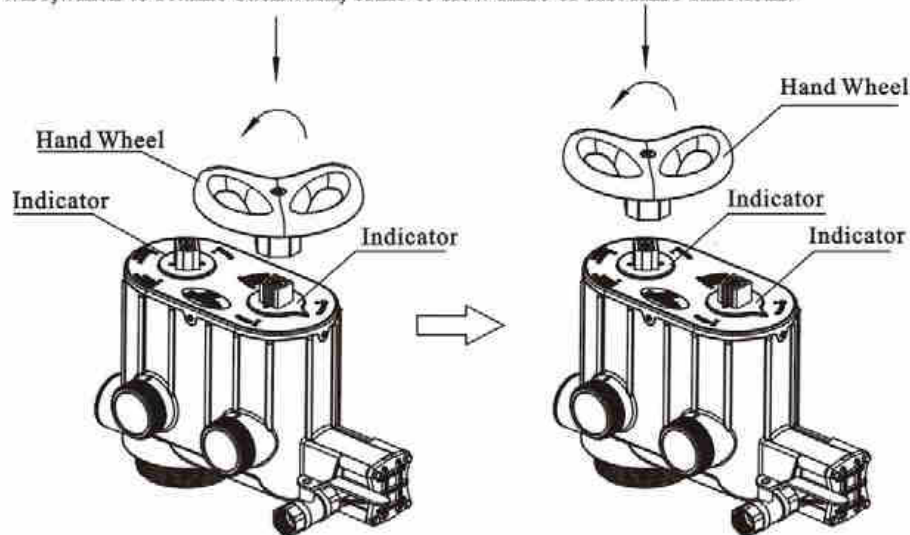

# MODEL: F77BS-51215/F77AS-61215/F77CS-91215



## 2.2. Indicator

### A. F77BS/51215, F77AS/61215

State		Indicator Position
F77BS	F77AS	
Service	Service Brine Refill	
Back-wash	Back-wash	
/	Brine & Slow Rinse	
Fast Rinse	Fast Rinse	



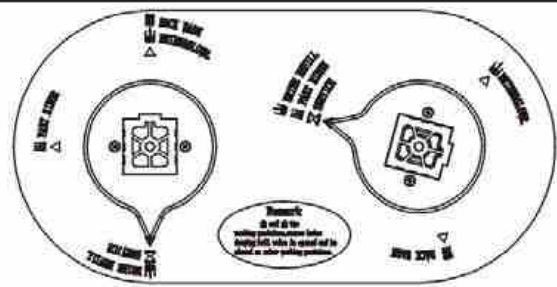
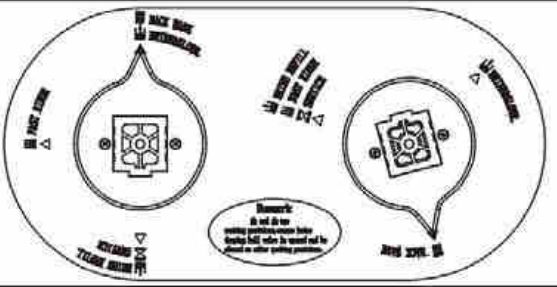
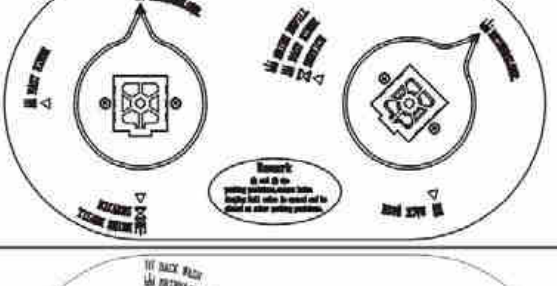
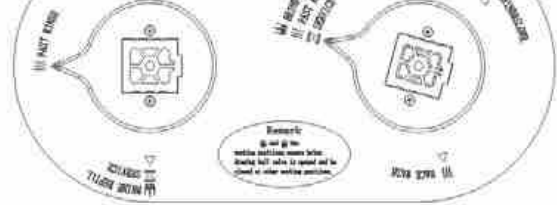



**MODEL: F77BS-51215/F77AS-61215/F77CS-91215**

**B. F77CS/91215**

State		Indicator Position
UF	Floating Bed	
Service Brine Refill	Service Brine Refill	
/	Settling Bed	<p align="center"><b>Close water inlet</b></p> 
Backwash	/	
Brine & Slow Rinse	Brine & Slow Rinse	
Fast Rinse	Fast Rinse	

MODEL: F77BS-51215/F77AS-61215/F77CS-91215

**2.3. Figure on Decoration Cover and its English Description**

English	Figure	Description
SERVICE		In service state
BACK WASH		In backwash state
BRINE & SLOW RINSE		In brine & slow rinse state
BRINE REFILL		In brine refill state
FAST RINSE		In fast rinse state
	/	Remark:  and  two working positions, ensure ball valve is opened and be closed at other working positions manually.

### 3. Applications

#### 3.1. Flow Chart

For filter valve only has service, backwash and fast rinse.

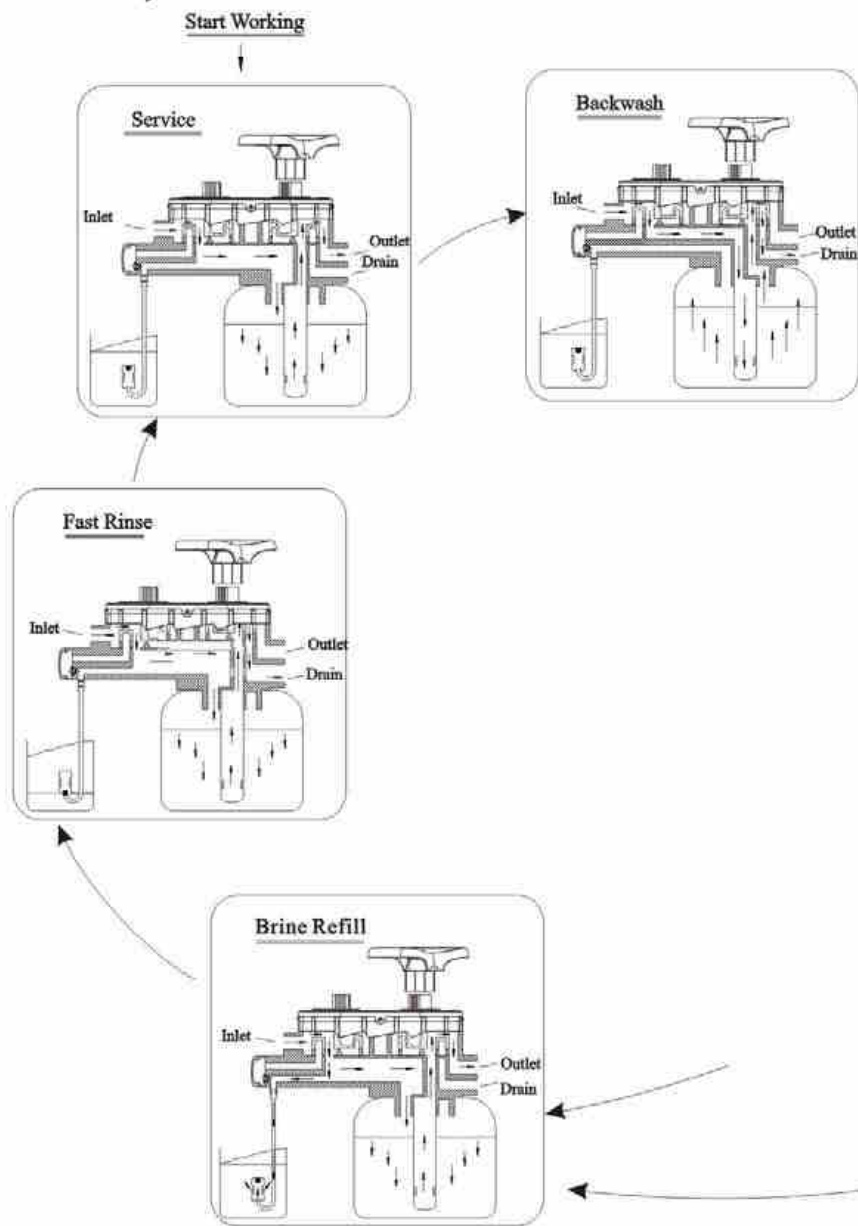

DF

UF

**Brine & Slow Rinse**

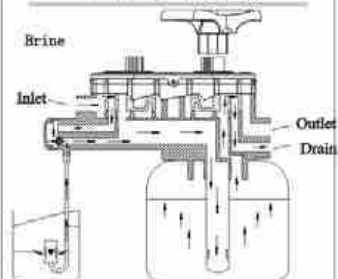

**Slow Rinse**

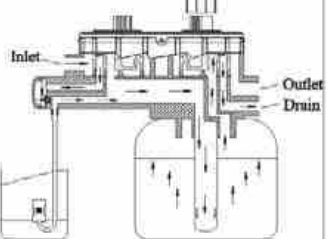

**Brine & Slow Rinse**

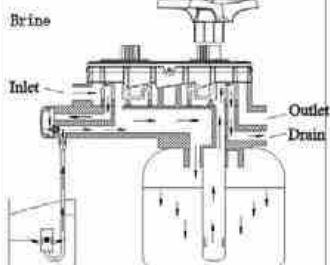

**Slow Rinse**

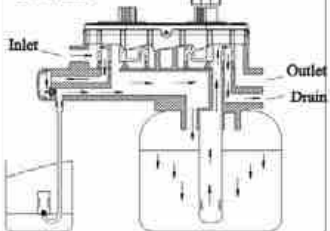



## MODEL: F77BS-51215/F77AS-61215/F77CS-91215

### 3.2. System Configuration and Flow Rate Curve

#### A. Product Configuration

Product configuration with tank, resin volume, brine tank and injector.

Tank Size (mm)	Resin Volume (L)	Flow Rate (t/h)	Brine Tank Size (mm)	The Minimum Salt Consumption for Regeneration (Kg)	Injector Model
φ 750 × 1850	450	11.0	φ 840 × 1335	67.50	7702
φ 900 × 2400	900	16.0	φ 1080 × 1460	135.00	7703
φ 1000 × 2400	1100	20.0	φ 1240 × 1575	165.00	7704

Attention: The flow rate calculation is based on service velocity 25m/hr; the minimum salt consumption for regeneration calculation is based on salt consumption 150g / L (Resin).

#### B. Flow Rate characteristic

##### 1). Pressure-flow rate curve

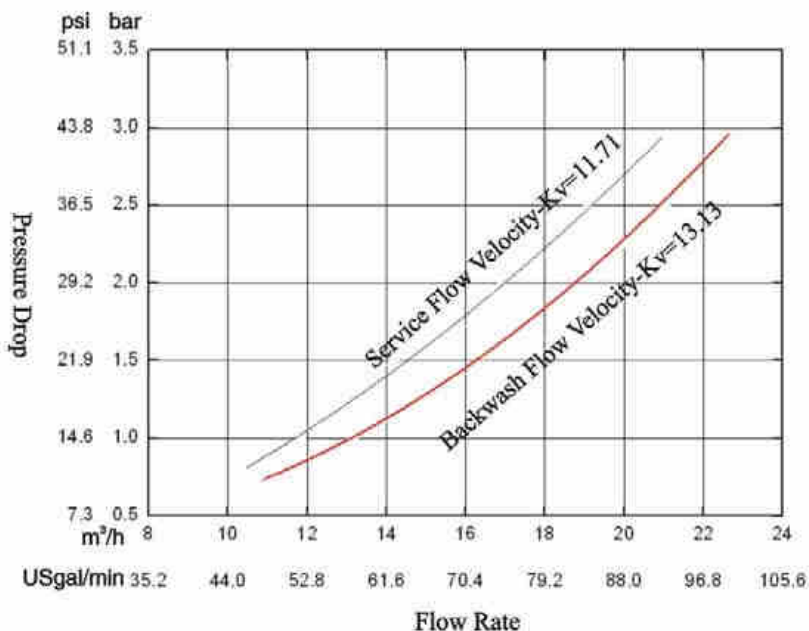

MODEL: F77BS-51215/F77AS-61215/F77CS-91215

2). Injector parameter table

Inlet Pressure	Draw Rate (L/M)				
	7701 Coffee	7702 Pink	7703 Yellow	7704 Blue	7705 White
0.20	18.72	25.83	35.52	42.27	49.25
0.25	26.83	32.42	45.59	57.02	63.58
0.30	32.08	39.41	51.16	64.90	72.37
0.35	37.56	49.79	59.17	70.75	79.85
0.40	42.14	54.77	63.77	76.46	85.86

3). Configuration for Standard Injector and Drain Line Flow Control

Tank Dia. mm	Injector Mode	Injector Color	Draw Rate	Slow Rinse	DLFC & Holes Quantity	Backwash / Fast Rinse
			L/m	L/m		t/h
700	7701	Coffee	32	20	0	7.5
750	7702	Pink	39.5	26.5	0	7.5
800	7702	Pink	39.5	26.5	1 × $\phi$ 6	9.2
850	7703	Yellow	51.2	33.3	1 × $\phi$ 6	9.2
900	7703	Yellow	51.2	33.3	2 × $\phi$ 6	10.2
1000	7704	Blue	64.9	42	3 × $\phi$ 6	11.2
1050	7705	White	72.4	48.7	4 × $\phi$ 6	13

Remark:

- Above data for the product configuration and relevant characteristics are only for reference. When put in practice, please subject to the different requirements of raw water hardness and application.
- Above parameter is tested under 0.3MPa inlet pressure.
- Holes quantity is the holes number on DLFC. Diameter of hole is  $\phi$  6, the number refer to above table.

### 3.3. Parameter settlement

#### ① Service time T1

Water treatment capacity:

$$Q = V_r \times K \div Y_D \quad (\text{m}^3)$$

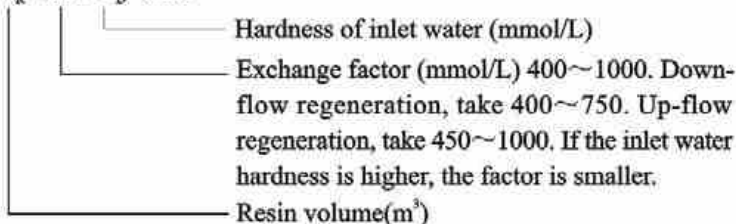

By hours:  $T1 = Q \div Q_h$  (hour)

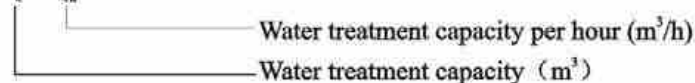

By days:  $T1 = Q \div Q_d$  (Day)

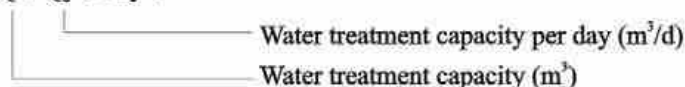

#### ② Backwash time T2

It is subject to the turbidity of inlet water. Generally, It is suggested to be set 10 ~ 15 minutes. The higher the turbidity is, the longer backwash time can be set. However, if the turbidity is more than 5FTU, it should be better to install a filter in front of the exchanger.

#### ③ T3 Brine & slow rinse time T3

$$T3 = (40 \sim 50) \times H_r \quad (\text{min})$$

$$\text{Generally, } T3 = 45H_r \quad (\text{min})$$

In this formula,  $H_r$  — The height of resin in exchange tank (m.)

#### ④ T4 Brine refill time T4

$$\text{Down-flow regeneration: } T4 = 0.45 \times V_r \div \text{Brine refill speed} \quad (\text{min.})$$

$$\text{Up-flow regeneration: } T4 = 0.34 \times V_r \div \text{Brine refill speed} \quad (\text{min.})$$

In this formula:  $V_r$  — Resin volume ( $\text{m}^3$ )

The Brine refill speed is related to inlet water pressure. It is suggested to lengthen 1~2 minutes of calculated brine refill time to make sure there is enough water in tank. (

The condition is that there is a level controller installed in the brine tank)

#### ⑤ T5 Fast rinse time T5

$$T5 = 12 \times H_r \quad (\text{min})$$

## MODEL: F77BS-51215/F77AS-61215/F77CS-91215

Generally, the water for fast rinse is 3 ~ 6 times of resin volume. It is suggested to be set 10 ~ 16 minutes, but subject to the outlet water reaching the requirement.

The calculation of parameters for each step is only for reference, the actual proper time will be determined after adjusting by water exchanger supplier. This calculation procedure of softener is only for industrial application; it is not suitable for small softener in residential application.

### **3.4. Trial running**

After installing the multi-functional flow control valve on the resin tank with the connected pipes, as well as setting up the relevant parameter, please conduct the trial running as follows:

A. Close the inlet valve B & C, and open the bypass valve A. After cleaning the foreign materials in the pipe, close the bypass valve A. (As Figure 1-1 shows)

B. Fill the brine tank with the planned amount of water and adjust the air check valve.

Then add solid salt to the tank and dissolve the salt as much as possible.

C. Switch hand wheel to Backwash position. Slowly open the inlet valve B to 1/4 position, making the water flow into the resin tank; you can hear the sound of air-out from the drain pipeline. After all air is out of pipeline, then open inlet valve B completely and clean the foreign materials in the resin tank until the outlet water is clean. It will take 8~10 minutes to finish the whole process.

D. Switch two hand wheels to Brine & Slow Rinse position. Open the ball valve. The air check valve close when control valve finished sucking brine, then slow rinse start to work around twenty minutes, close ball valve. It is about 60~65minutes for whole process.

E. Switch two hand wheels to fast rinse position. It takes about 10~15minutes, Take out some outlet water for testing: if the water hardness reach the requirement, and the chloridion in the water is almost the same compared with the inlet water, then go to the next step.

F. Switch two hand wheels to Service/Brine Refill position. Open ball valve, brine tank is being refilled with water to the required level. Close manual ball valve, system start to running.

#### **Note:**

● If water inflow too fast, the media in tank will be damaged. When water inflow slowly, there is a sound of air emptying from drain pipeline.

● After changing resin, please empty air in the resin according to the above Step C.

● The time for Backwash, Brine& Slow Rinse, Brine Refill and Fast Rinse position can be set and executed according to the calculation in the formula or suggestions from the control valve suppliers.

### 3.5. Usage

After being accomplished installation, parameter setting and trial running, the valve could be put into use. In order to ensure the quality of outlet water can reach the requirement, the user should complete the below works:

- ① Ensure that there is solid salt all the time in the brine tank in the course of using when this valve is used for softening.
- ② Test the outlet water and raw water hardness at regular time. When the outlet water hardness is unqualified, please switch hand wheel and the valve will temporary regenerate from step C to F again.
- ③ When the feed water hardness change a lot, reference parameter settlement to adjust the cycle Water capacity.

### 3.6. Trouble-Shooting

Problem	Cause	Correction
1. Softener supply hard water.	A. Bypass valve is open or leaking. B. No salt in brine tank. C. Injector plugged. D. Insufficient water flowing into brine tank. E. Leak at O-ring on riser pipe. F. Internal valve leak.	A. Close or repair bypass valve. B. Add salt to brine tank and maintain salt level above water level. C. Change or clean injector. D. Check brine tank refill time. E. Make sure riser pipe is not cracked. Check o-ring and tube pilot. F. Change valve body.
2. Softener fails to draw brine.	A. Line pressure is too low. B. Brine line is plugged or leaking C. Injector is plugged. D. Internal control leak. E. Ball valve failure	A. Increase line pressure. B. Clean brine line. C. Replace injector. D. Replace valve body. E. Open ball valve.
3. Excessive water in brine tank.	A. Overlong refilling time. B. Foreign material in brine line.	A. Reset correct refilling time. B. Clean brine line.
4. Pressure lost	A. Iron in the water supply pipe. B. Iron mass in the softener.	A. Clean the water supply pipe. B. Clean valve and add resin cleaning chemical, increase frequency of regeneration.
5. Loss of mineral through drain line.	A. Air in water system.	A. Assure that well system has proper air eliminator control.
6. Too much water in brine tank.	A. ball valve doesn't close B. Injector blocked. C. Foreign matter in brine valve.	A. Close ball valve. B. Clear or replace injector. C. Clear or replace brine valve.
7. Drain flows continuously.	A. Internal valve leak.	A. Check and repair valve

# MODEL: F77BS-51215/F77AS-61215/F77CS-91215

## 3.7. Assembly & Parts

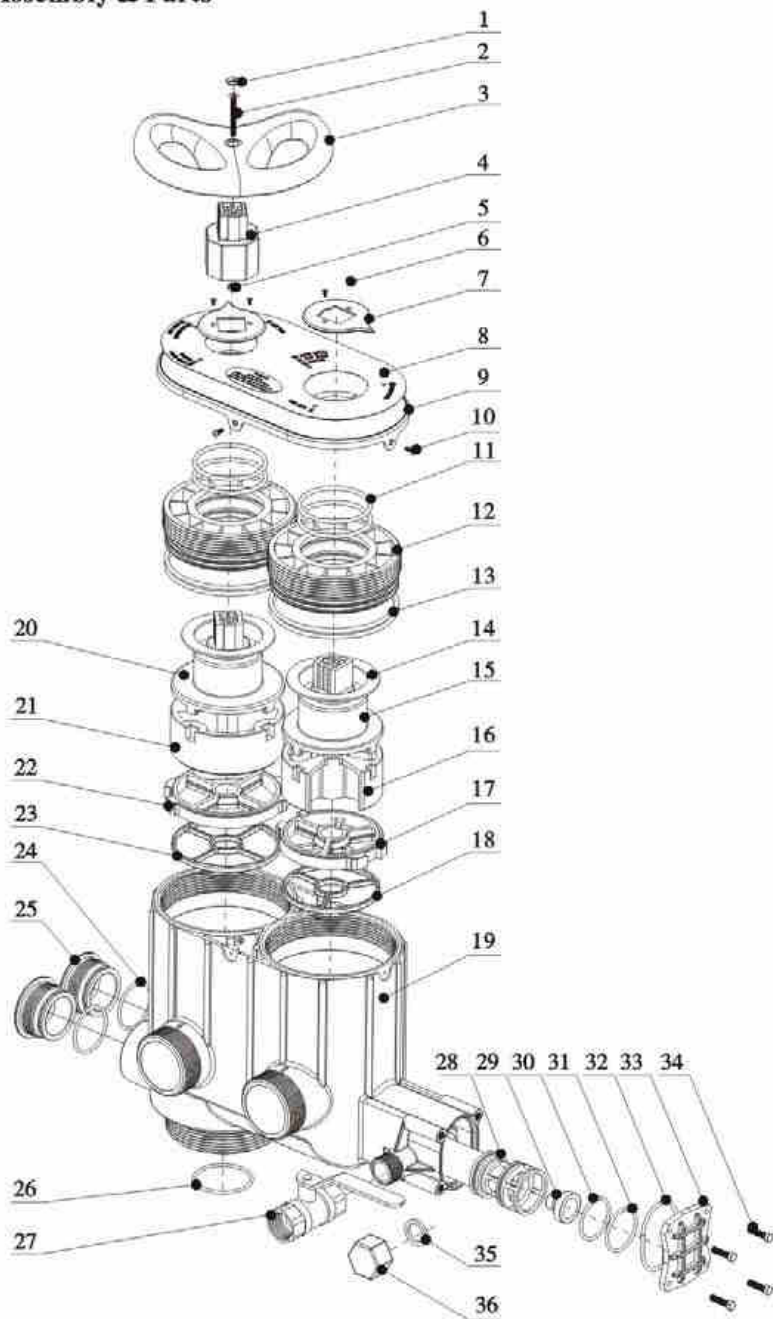

MODEL: F77BS-51215/F77AS-61215/F77CS-91215

Item Number	Description	Quantity	Part Number		
			61215	51215	91215
1	Label	1	8860001	8860001	8860001
2	Screw, Cross M4X40	1	8902013	8902013	8902013
3	Hand Wheel	1	8253041	8253041	8253041
4	Fixed Connector	1	8109030	8109030	8109030
5	Hexagonal Nut	1	8940002	8940002	8940002
6	Screw, Cross ST2.2 × 6.5	4	8909024	8909024	8909024
7	Indicator	2	8441002	8441002	8441002
8	Sticker	1	8869008	8869008	8869009
9	Dust Cover	1	8444021	8444021	8444021
10	Screw, Cross ST 2.9 × 9.5	8	8909008	8909008	8909008
11	O-ring 59.92 × 3.53	4	8378110	8378110	8378110
12	Pressure nut	2	8092009	8092009	8092009
13	O-ring 107.54 × 3.53	4	8378112	8378112	8378112
14	Anti-friction Washer	2	8216006	8216006	8216006
15	Shaft	1	8258012	8258012	8258012
16	Moving Disk	1	8459023	8459023	8459023
17	Fixed Disk	1	8469021	8469021	8469021
18	Sealing Ring	1	8370042	8370042	8370042
19	Valve Body	1	5022036	5022038	5022040

MODEL: F77BS-51215/F77AS-61215/F77CS-91215

20	Shaft	1	8258005	8258005	8258005
21	Moving Disk	1	8459024	8459024	8459024
22	Fixed Disk	1	8469022	8469022	8469022
23	Sealing Ring	1	8370044	8370044	8370044
24	O-ring 40 × 2.65	2	8378091	8378091	8378091
25	Blocker	1	8323009	8323009	8323009
26	O-ring 48.9 × 2.62	1	8378071	8378071	8378071
27	Manual ball valve	1	2976009	/	2976009
28	Throat, Injector	1	8467019	/	8467019
29	Nozzle, Injector	1	8454019	/	8454019
30	O-ring 35.5 × 2.65	1	8378086	/	8378086
31	O-ring 36.5 × 2.65	1	8378089	/	8378089
32	O-ring 52 × 3	1	8378096	8378096	8378096
33	Injector Cover	1	8315007	8315007	8315007
34	hexagon-headed Bolt M5 × 20	4	5851006	5851006	5851006
35	Sealing Ring	1	/	8371019	/
36	Blind Nut	1	/	8940004	/



## 4. Warranty Card

Dear client:

This warranty card is the guarantee proof of RUNXIN brand multi-functional flow control valve. It is kept by client self. You could get the after-sales services from the supplier which is appointed by RUNXIN manufacturer. Please keep it properly. It couldn't be retrieved if lost. It couldn't be repaired free of charge under the below conditions:

1. Guarantee period expired.(One year);
2. Damage resulting from using, maintenance, and keeping that are not in accordance with the instruction;
3. Damage resulting from repairing not by the appointed maintenance personnel;
4. Content in guarantee proof is unconfirmed with the label on the real good or be altered;
5. Damage resulting from force majeure.

Product Name		Multi-functional Flow Control Valve for Water Treatment Systems			
Model		Code of Valve Body			
Purchase Company Name		Tel/Cel.			
Problem					
Solution					
Date of Repairing		Date of Accomplishment		Maintenance Man Signature	

When product need warranty service, please fill in the below content and sent this card together with the product to the appointed suppliers or Runxin company.

End-user Company Name		Tel/Cel.			
Purchase Company Name		Tel/Cel.			
Model	Code of Valve Body				
Tank Size $\phi$ ×		Resin Tank Size	L	Raw Water Hardness	mmol/L
Water Source: Ground-water <input type="checkbox"/> Tap Water <input type="checkbox"/>		Water Treatment Capacity	m <sup>3</sup>	Backwash Time	min
Brine & Slow Rinse Time	min	Brine Refill Time	min	Fast rinse Time	min
Problem Description					



---

**WENZHOU RUNXIN MANUFACTURING MACHINE CO.,LTD**

ADD: Jinger Road, Shatou Group, Linjiang, Lucheng District, Wenzhou, Zhejiang, China

Tel: +86-577-88635628 88630038 Fax: +86-0577-88633258

Http://www.run-xin.com Email:sales@run-xin.com