

Longer Precision Pump Co.,Ltd.

3rd/4th floor, Building 6B, University Science Park
Baoding National, High-Tech Industrial
Development Zone , Baoding, Hebei, China 071051
Tel: +86-312-3110087
Fax: +86-312-3168553
E-mail: longer@longerpump.com
Https://www.longerpump.com

Peristaltic Pump
Laboratorial Syringe Pump
Industrial Syringe Pump
Micro Gear Pump
Piston Pump
Pump System
OEM

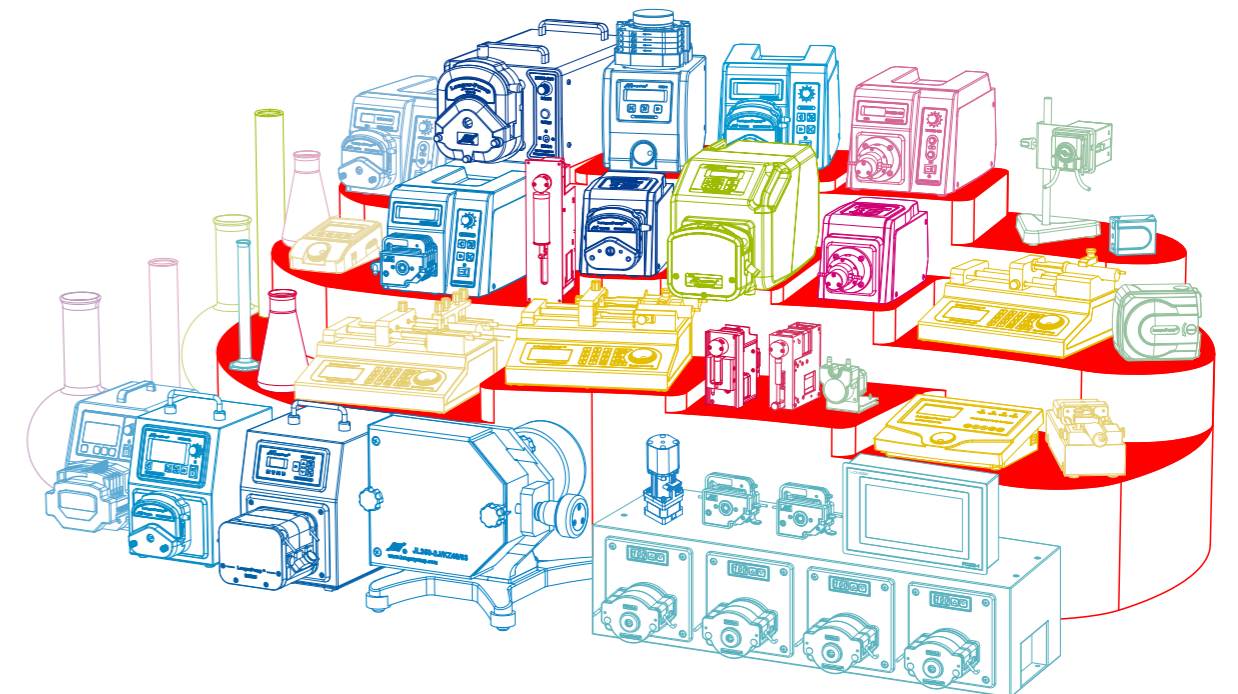

*Please determine the product material according to fluid media and environment.

Longer Precision Pump Co., Ltd.

 www.longerpump.com

2023 / 2024

About Us

Longer Precision Pump Co., Ltd, was founded in 1997, and is a wholly owned subsidiary of the Halma Group, and is affiliated to Healthcare Sector which specializes in R&D, production and the sale of precise fluid transfer and handling devices.

Longer has always persisted on customer orientation, and we provide our customers with safe, high accuracy and quality fluid transfer devices and solutions. Our products not only include peristaltic pumps, laboratorial syringe pumps, industrial syringe pumps, micro-gear pumps, dispensing and filling systems, etc., which can also be customized and designed to OEM pumps according to the clients' different needs. Longer has more than 40 series of products with over 600 specifications. We are hyper-focused on the quality, delivery, value and technology of products and services, and provide products and services for the Pharmaceutical, Medical, Environmental monitoring and Laboratory fields, etc.

All of our products are produced with the most advanced manufacturing equipment and testing devices under the assurance of ISO9001:2015. Additionally, we have set up Research Centres in Baoding and Shanghai with branches in the United States. We serve customers in more than 130 countries and territories through diversified marketing channels.

Halma is a global group of life-saving technology companies. Named as one of Britain's Most Admired Companies, with group of around 45 companies provide innovative products and services that help solve many of the key problems facing the world today. Halma employs over 7,000 people in more than 20 countries, with major operations in the UK, Mainland Europe, the USA and Asia Pacific. Halma is listed on the London Stock Exchange and is a constituent of the FTSE 100.

Halma's purpose is to grow a safer, cleaner, healthier future for everyone, every day.



Enterprise Intellectual Property



Product Qualification Certificate

Peristaltic Pump Configuration

Peristaltic Pump Features
Non-contamination, easy to clean, low shear, simple maintenance

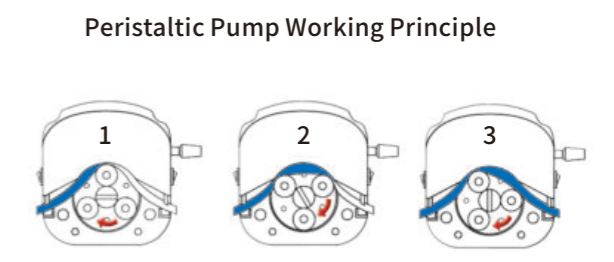

Laboratorial Syringe Pump Configuration

Laboratorial Syringe Pump Features
High accuracy, diversification, laboratory use only

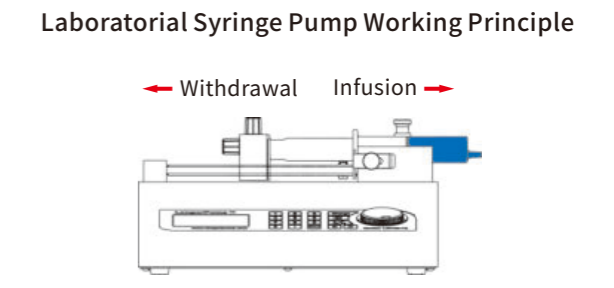

Industrial Syringe Pump Configuration

Industrial Syringe Pump Features
Intelligent, high accuracy, embedded installation and OEM use only

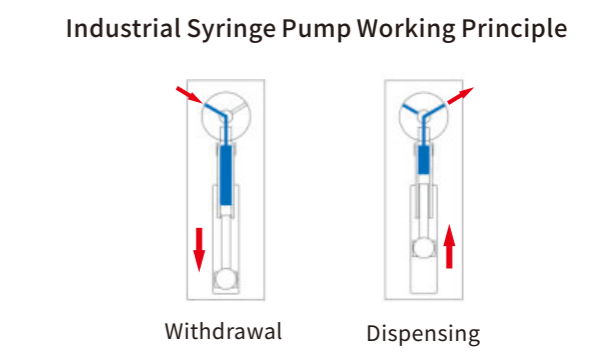

Gear Pump Configuration

Gear Pump Features
Low pulse constant flow rate, higher pressure than peristaltic pump

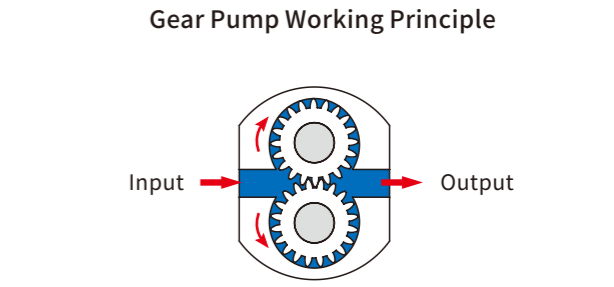

Piston Pump Configuration

Piston Pump Features
High accuracy, compact size, non-worn and long life

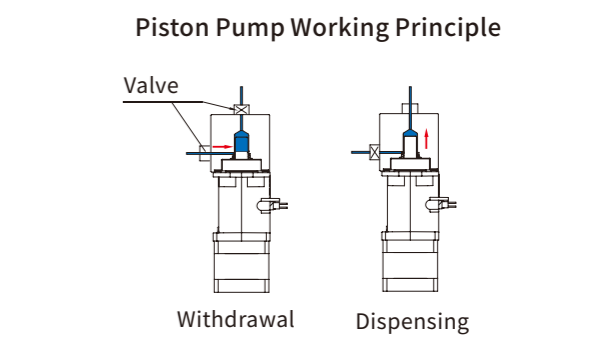

Table of Contents

Biosicon®Silicone Tubing		01
Peristaltic Pump Head	Max. Flow Rate(Single Channel)	02-11
Intelligent Peristaltic Pump		12-13
L100-1F, L300-1F, L600-1F	3000mL/min	12
L100-1FS, L300-1FS, L600-1FS	3000mL/min	13
Basic Peristaltic Pump		14-21
L100-1E	380mL/min	14
BT100-3J	600mL/min	15
BT300-2J, BT600-2J	3600mL/min	16
WT600-2J	4.2-12000mL/min	17
WT600-3J	4.2-12000mL/min	18
YT600-1J	600-22000mL/min	19
JL350-2J	1.3-35L/min	20
BQ50-1J	20mL/min	21
Standard Peristaltic Pump		22
L100-1S-2	500mL/min	22
Flow Rate Peristaltic Pump		23-24
LEAD-2	1200mL/min	23
BT100-1L	380mL/min	24
Dispensing Peristaltic Pump		25-28
BT100-1F	600mL/min	25
BT300-1F	1800mL/min	26
WT600-1F	0.7-6600mL/min	27
WT600-4F	100-22000mL/min	28
Industrial Peristaltic Pump		29-32
G100-2J	500mL/min	29
G300-2J/G600-1J	0-3000mL/min	30
G300-3F	0-5500mL/min	31
dPOFLEX® GP01/BP01	17L/min	32
dPOFLEX®Explosion Proof Motor Pump		33
Laboratorial Syringe Pump		34-42
dLSP 500 series	57.621mL/min	34
L0107 series	1325µL/min	35
TJ-3A/W0109-1B, TS-1B/W0109-1B	52.95mL/min	36
TJP-3A/W0109-1B	52.95mL/min	37
TJ-4A/SL0104-1A, TJ-4A/SL0107-1A	213µL/min	38
LSP series	86.699mL/min	39
LSP01-3A, LSP02-2B	86.699mL/min	40
LSP01-1C	14.068mL/min	41
LSP01-1BH	124.361mL/min	42
Industrial Syringe Pump		43-44
SP1-CX, MSP1-CX		43
MSP1-D1, MSP1-E1		44
Industrial Multi-Channel Syringe Pump		45
Micro Gear Pump		46
Micro Piston Pump		47
Medical Dialysis Pump		48
Peristaltic Pump Filling System		49-51
Syringe Pump Filling System		52
OEM Peristaltic Pump Head		53-54
User Driven OEM Peristaltic Pump		55-56
T-S500&WX10-14-H T-S502&JY10-14-H	40mL/min	55
T-S501&JY15-12-C T-S400	170mL/min	56
User Variable Speed OEM Peristaltic Pump		57-62
T100&WX10-14Series	40mL/min	57
T100&JY15-12Series	170mL/min	58
T100-S320	42mL/min	59
T100/T300/T600Series	2200mL/min	60
DC Drushless Motor Series	2500mL/min	61-62
Fixed Speed OEM Peristaltic Pump		63-69
Peristaltic Pump Hose		70-71
Flow Reference Curve		72-74
Peristaltic Pump Accessories		75

NEW

High Precise Filling System dPOFLEX® PFU/PFS



Industrial Peristaltic Pump dPOFLEX® GP01/BP01



Digital Laboratory Syringe Pump dLSP 500® Series



CE

Biosicon®Silicone Tubing



◎ Main Features

BioSicon silicone tubing is based on Longer's years of research and application experience in fluid transfer and process technology with peristaltic pump, and made of refined silicone polymer. It has high transparency, good wear resistance, low permeability, strong restititional resilience, and is not easy to deform after compression, which is the optimal tubing for peristaltic pumping applications.

- >USP<88> Class VI
- >USP<87> Requirement
- >FDA regulations 21CFR 177.2600
- >NSF 51
- >ROHS
- >REACH

◎ Typical Applications

- Media addition
- Ultrafiltration and concentration
- IVD reagent dispensing and filling
- Media filling
- Coolant transfer
- Fermentation control
- Oral liquids filling
- Vaccine filling
- Buffer transfer
- Saline transfer



Double-bagged, following GMP guidelines



Lot-traceable and accompanied by documentation to make the validation easy

◎ Tubing Specification

Product Code	Tubing Size	ID (mm)	OD (mm)	Wall Thickness (mm)	Length (m/pkg)	Hardness (Shore A)	Tensile Strength (MPa)	Elongation at Break (%)	Tear Strength (kN/m)	Material
05.50.741	14#	1.6	5	1.7	15	50-55	≥7.0	≥500	≥30	Platinum-cured silicone
05.50.742	19#	2.4	5.8	1.7	15	50-55	≥7.0	≥500	≥30	
05.50.743	16#	3.2	6.4	1.6	15	50-55	≥7.0	≥500	≥30	
05.50.744	25#	4.8	8	1.6	15	50-55	≥7.0	≥500	≥30	
05.50.745	17#	6.4	9.6	1.6	15	50-55	≥7.0	≥500	≥30	
05.50.746	18#	7.9	11.1	1.6	15	50-55	≥7.0	≥500	≥30	
05.50.747	15#	4.8	9.6	2.4	15	50-55	≥7.0	≥500	≥18	
05.50.748	24#	6.4	11.2	2.4	15	50-55	≥7.0	≥500	≥18	
05.50.749	35#	7.9	12.7	2.4	15	56-60	≥7.0	≥300	≥18	
05.50.750	36#	9.5	14.3	2.4	15	56-60	≥7.0	≥300	≥18	
05.50.751	73#	9.5	16.1	3.3	15	50-55	≥7.0	≥500	≥18	
05.50.752	82#	12.7	19.3	3.3	15	50-55	≥7.0	≥500	≥18	
05.50.753	86#	9.5	22.3	6.4	15	50-55	≥7.0	≥500	≥18	
05.50.754	88#	12.7	22.3	4.8	15	56-60	≥7.0	≥300	≥18	
05.50.755	90#	19	31.8	6.4	15	50-55	≥7.0	≥500	≥18	
05.50.756	92#	25.4	35	4.8	15	50-55	≥7.0	≥500	≥18	
05.50.760	26#	6.4	13	3.3	15	50-55	≥7.0	≥500	≥18	
05.50.761	184#	15.9	22.5	3.3	15	50-55	≥7.0	≥500	≥18	
05.50.762	185#	8	16	4	15	50-55	≥7.0	≥500	≥18	
05.50.763	186#	12	20	4	15	50-55	≥7.0	≥500	≥18	
05.50.764	187#	16	24	4	15	50-55	≥7.0	≥500	≥18	
05.50.765	188#	17	25	4	15	50-55	≥7.0	≥500	≥18	

Temperature range: -50°C to 250°C. Can be sterilized repeatedly by high temperature and ultraviolet.

Easy-load Pump Head

YZ1515x, YZ2515x

Classic design, simple operation, wide flow range.

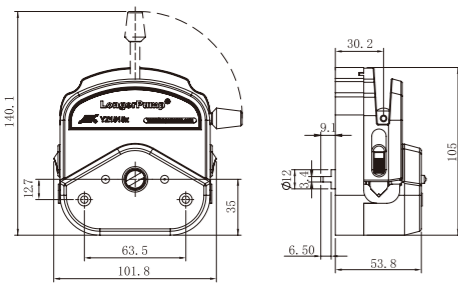

PPS housing
(Excellent chemical resistance)

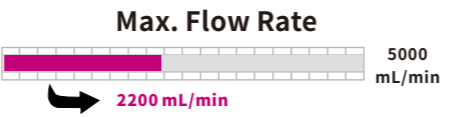

PESU

YZII15, YZII25

Patented Design
Patent Number: 200620026529.1

Based on the classic design of YZ1515x/YZ2515x, YZII15/YZII25 have a special tubing retention linkage which makes tubing loading easily and rapidly. YZII25 accepts more suitable tubing than YZ2515x and provides a wider flow range.

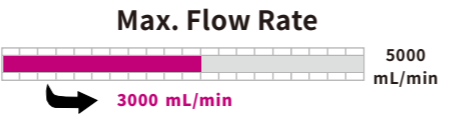
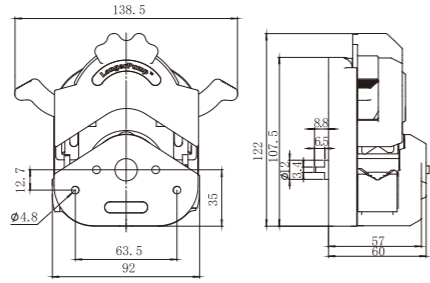

PESU

Tubing Loading Comparison



Tubing clamber needs to be lifted manually
YZ1515x/YZ2515x



Tubing clamber can be automatically opened
YZII15/YZII25

Model	Product Code	Roller Number	Roller Material	Housing Material	Speed (rpm)	Tubing	Max. Flow Rate (mL/min)	Weight (kg)
YZ1515x-A	05.01.52A	3	Stainless steel	PESU	≤600	13" 14" 19" 16"	2200	0.4
YZ1515x-B	05.01.52B	6		PESU			1450	
YZ1515x-C	05.01.52C	3		PPS		2200		
YZ1515x-D	05.01.52D	6		PPS		1450		
YZ2515x-A	05.01.53A	3	Stainless steel	PESU	≤600	15" 24"	1600	0.35
YZ2515x-C	05.01.53C			PPS			1600	
YZII15	05.01.55A	3	Stainless steel	PESU	≤600	13" 14" 19" 16" 25" 17" 18"	2200	0.35
YZII25	05.01.56A						3000	

Easy-load Industrial Pump Head

YZ35-13

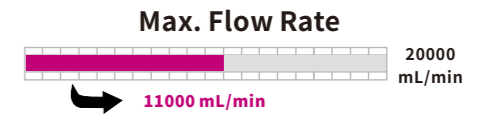

Product Code
05.01.58A(Long shaft)
05.01.58B(Short shaft)

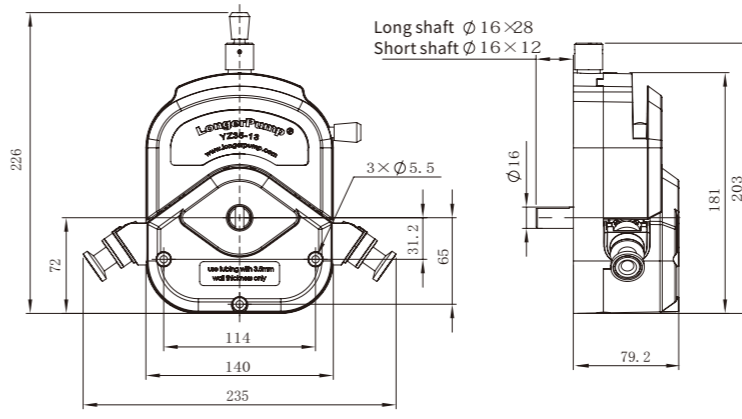

For continuous tubing



For tubing with fittings



Tubing Fitting Assembly

Model	Shaft	Product Code	Roller Number	Roller Material	Housing Material	Speed (rpm)	Tubing	Max. Flow Rate (mL/min)	Weight (kg)
YZ35-13-A	Long	05.01.58A	3	Stainless steel	PSU	≤600	73" 82"	11000	1.65
YZ35-13-B	Short	05.01.58B							

Mainly for industrial applications

Two tubing retention modes

- Continuous tubing
- Tubing with fittings

Occlusion Adjustment



① Standard position



② Decrease occlusion



③ Increase occlusion

PUMP HEADS

PUMP HEADS

Standard Pump Head

BZ Series



Original design, stable flow rate, each pump head accommodates a single size of tubing.

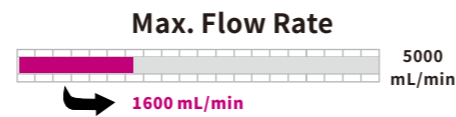
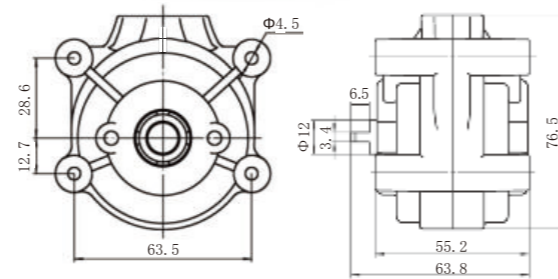

Flip-type Pump Head

FG15-13, FG25-13



Distinctive design, unique installation mode.

Tubing loading

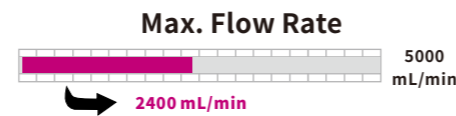
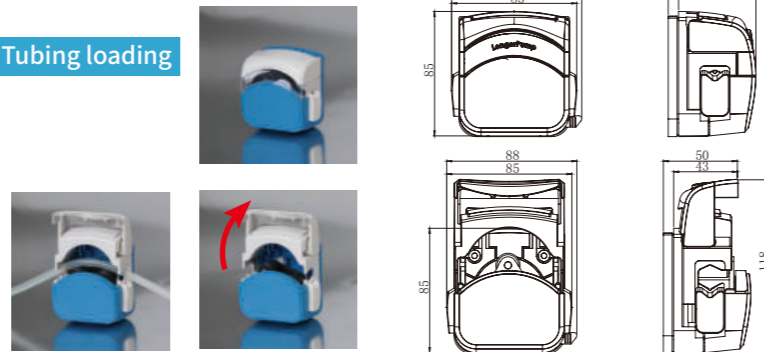

Model	Product Code	Roller Number	Roller Material	Housing Material	Speed (rpm)	Tubing	Max. Flow Rate (mL/min)	Weight (kg)	
BZ15-13-A	05.01.01A	3	Stainless steel	PC	≤600	14"	150	0.31	
BZ15-13-B	05.01.01B					16"	460		
BZ15-13-C	05.01.01C					25"	960		
BZ15-13-D	05.01.01D					17"	1600		
BZ25-13-B	05.01.00B					24"	1600		
FG15-13-A (Slot)	05.01.63A	3	PA6	IXEF	≤600	13" 14" 19"	2400	0.28	
FG15-13-B (Tang)	05.01.63B					16" 25" 17" 18"			
FG25-13-A (Slot)	05.01.64A					15" 24"			2200
FG25-13-B (Tang)	05.01.64B								

Multi-channel small flow Pump Head

DG Series

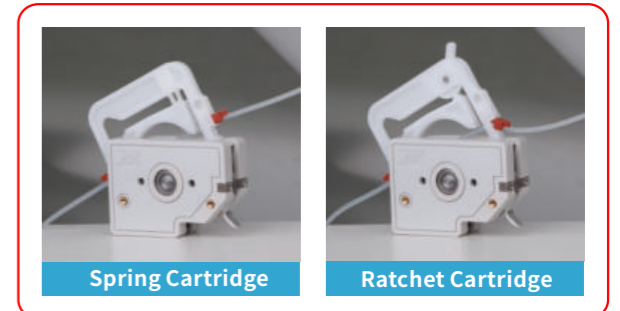
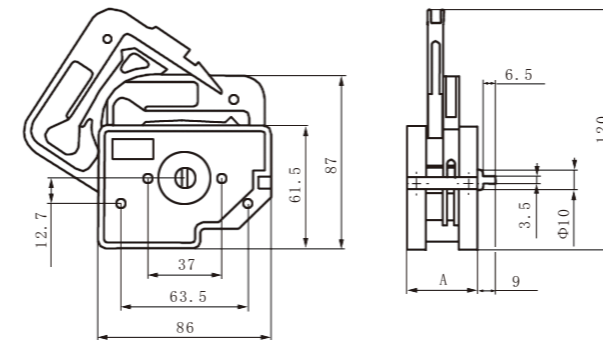
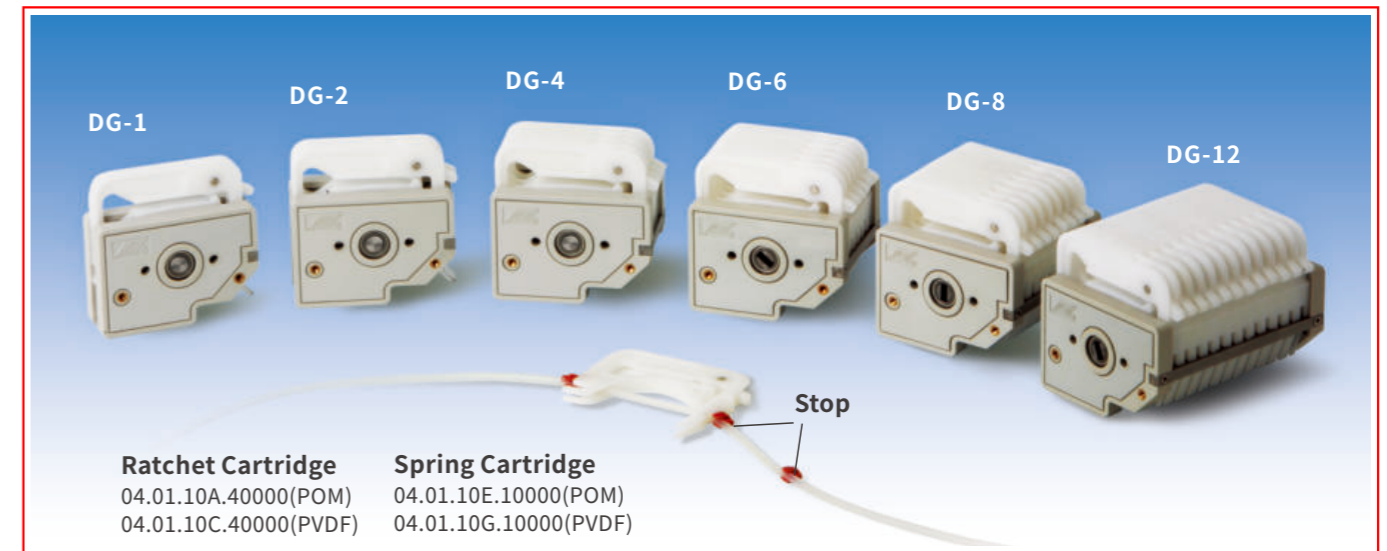
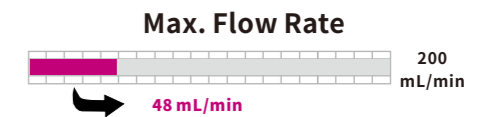

Discrete cartridge, special tubing sets, trigger structure of DG-1&DG-2. Spring cartridge can adjust the occlusion automatically to accept several different tubing wall thicknesses. Ratchet cartridge can adjust the occlusion by adjusting ratchet position to accept several different tubing wall thicknesses.

Model	Roller Number	Product Code	Cartridge Type	Roller Material	Cartridge Material	Channel Number	Speed (rpm)	Tubing	Max. Flow Rate (mL/min)	Weight (kg)		
DG-1-A/C	6	05.01.10A/C	Ratchet	Stainless Steel	DG-**-A/B cartridge material is POM 04.01.10A.40000	1	≤100	ID ≤ 3.17mm Wall Thickness 0.8mm-1.0mm	48 (Single Channel)	0.20		
DG-1-B/D	10	05.01.10B/D							32 (Single Channel)	0.21		
DG-1-E/G	6	05.01.10E/G	Spring						48 (Single Channel)	0.20		
DG-1-F/H	10	05.01.10F/H							32 (Single Channel)	0.21		
DG-2-A/C	6	05.01.11A/C	Ratchet			DG-**-C/D cartridge material is PVDF 04.01.10C.40000			2	48 (Single Channel)	0.26	
DG-2-B/D	10	05.01.11B/D								32 (Single Channel)	0.27	
DG-2-E/G	6	05.01.11E/G	Spring							48 (Single Channel)	0.26	
DG-2-F/H	10	05.01.11F/H								32 (Single Channel)	0.27	
DG-4-A/C	6	05.01.12A/C	Ratchet						DG-**-E/F cartridge material is POM 04.01.10E.10000	4	48 (Single Channel)	0.39
DG-4-B/D	10	05.01.12B/D									32 (Single Channel)	0.40
DG-4-E/G	6	05.01.12E/G	Spring	48 (Single Channel)	0.39							
DG-4-F/H	10	05.01.12F/H		32 (Single Channel)	0.40							
DG-6-A/C	6	05.01.13A/C	Ratchet	DG-**-G/H cartridge material is PVDF 04.01.10G.10000	6	48 (Single Channel)	0.51					
DG-6-B/D	10	05.01.13B/D				32 (Single Channel)	0.54					
DG-6-E/G	6	05.01.13E/G	Spring			48 (Single Channel)	0.51					
DG-6-F/H	10	05.01.13F/H				32 (Single Channel)	0.54					
DG-8-A/C	6	05.01.14A/C	Ratchet		DG-**-G/H cartridge material is PVDF 04.01.10G.10000	8	48 (Single Channel)	0.63				
DG-8-B/D	10	05.01.14B/D					32 (Single Channel)	0.67				
DG-8-E/G	6	05.01.14E/G	Spring				48 (Single Channel)	0.63				
DG-8-F/H	10	05.01.14F/H					32 (Single Channel)	0.67				
DG-12-A/C	6	05.01.15A/C	Ratchet	(* is 1,2,4,6,8,12)		12	48 (Single Channel)	0.88				
DG-12-B/D	10	05.01.15B/D					32 (Single Channel)	0.95				
DG-12-E/G	6	05.01.15E/G	Spring		48 (Single Channel)		0.88					
DG-12-F/H	10	05.01.15F/H			32 (Single Channel)		0.95					

Multi-channel medium flow Pump Head

DG15 Series

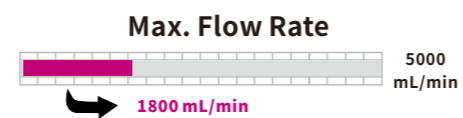
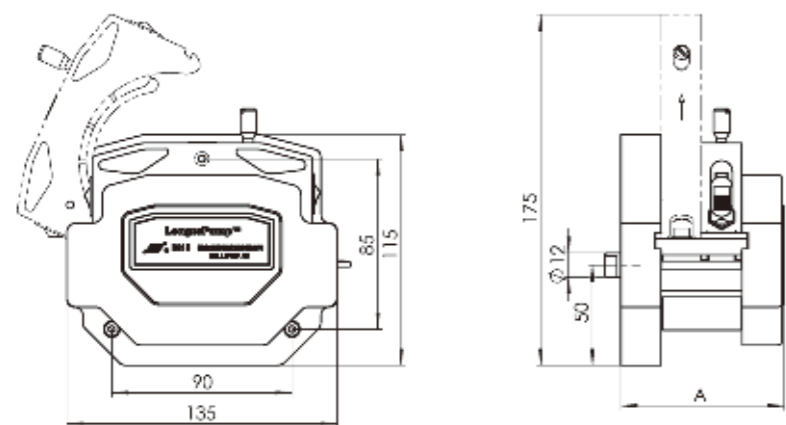

Pump Head type



DG15-24



DG15-28

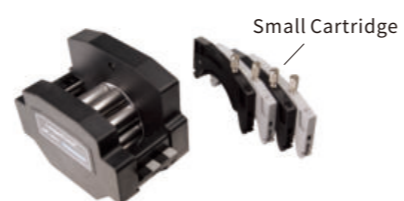

DG15-48

DG15 - 24: 2 Channels 4 Rollers
 DG15 - 28: 2 Channels 8 Rollers
 DG15 - 48: 4 Channels 8 Rollers

Patented design (Patent Number: 200520026479.2), DG15-24 can replace two stacked YZ1515X.
 DG15-28 and DG15-48 can provide bigger flow rates than DG-2 and DG-4.
 Adjustable occlusion can accept several different tubing wall thicknesses.

Model	Product Code	Channel Number	Roller Number	Roller Material	Cartridge Material	Speed (rpm)	Tubing	Max. Flow Rate (mL/min)	Weight (kg)
DG15-24	05.01.16A	2	4	Stainless steel	POM	≤600	16" 25" 17"	1800 (Single Channel)	0.82
DG15-28	05.01.17A	2	8			≤100	13" 14" ID≤3.17mm Wall thickness 1.0mm	75 (Single Channel)	0.67
DG15-48	05.01.18A	4	8			≤100	75 (Single Channel)	0.87	

Quick-load Pump Head

KZ25

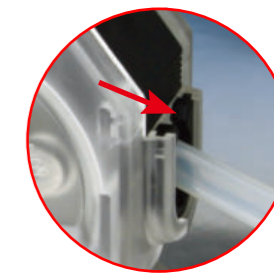
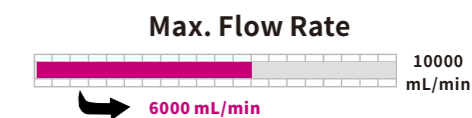

For continuous tubing



For tubing with fittings

Big flow rate up to 6000 mL/min, easy to load tubing with separated structure.
 Two tubing retention modes

- Continuous tubing
- Tubing with fittings

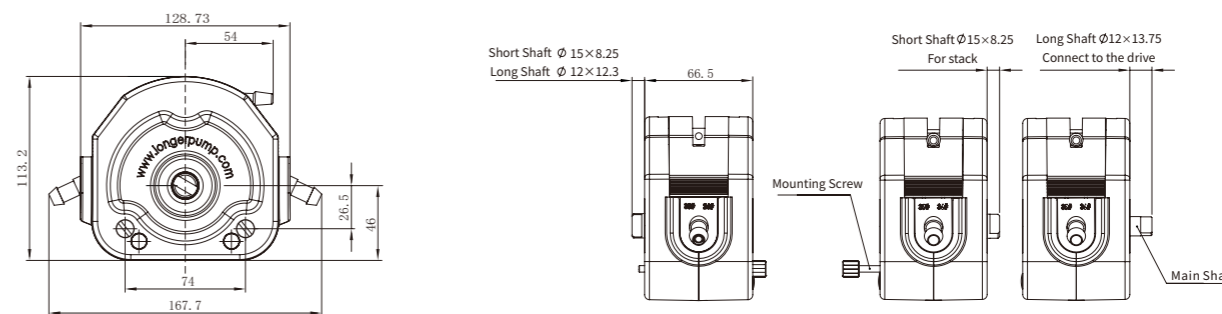

Model	Shaft	Product Code	Roller Number	Roller Material	Compression Block Material	Speed (rpm)	Tubing	Max. Flow Rate (mL/min)	Weight (kg)
KZ25-13-A	Long	05.01.25A	3	Stainless Steel	PPS	≤600	15" 24" 35" 36"	6000	0.79
KZ25-13-B	Short	05.01.25B							

Quick-load Industrial Pump Head

KZ35

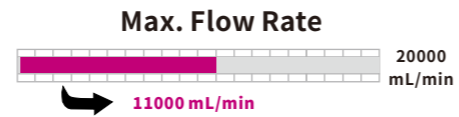

- Similar flow rate to YZ35-13
- 304 stainless steel
- Mainly for industrial applications
- Two tubing retention modes
- Continuous tubing
- Tubing with fittings



For continuous tubing



For tubing with fittings

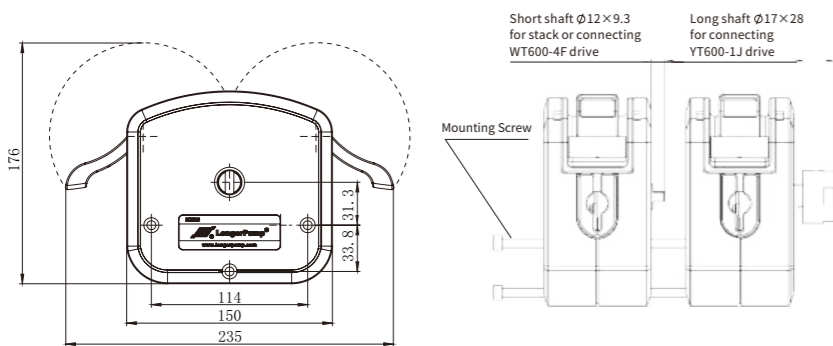
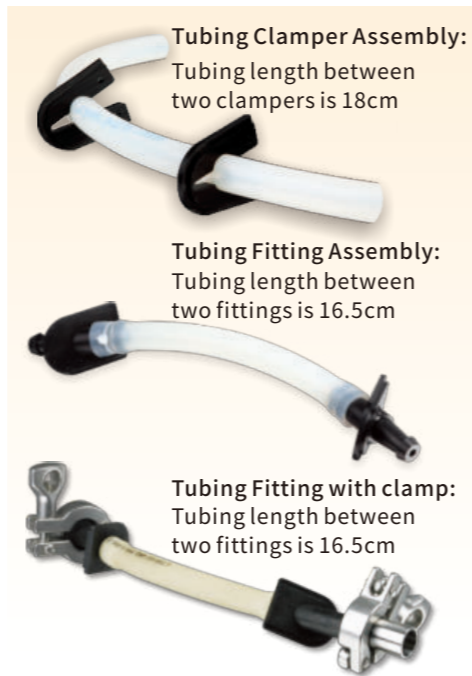

Model	Shaft	Product Code	Roller Number	Roller Material	Housing Material	Speed (rpm)	Tubing	Max. Flow Rate (mL/min)	Weight (kg)
KZ35-13-A	Long	05.01.26A	3	Stainless steel	Stainless steel	≤ 600	73" 82"	11000	3.7
KZ35-13-B	Short	05.01.26B							

dPOFLEX® Industrial Pump Head

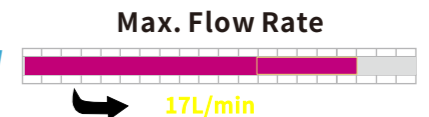

- LPH has low pulsation design for high flow rate accuracy
- GPH has two tubing retention modes: continuous tubing and tubing with fittings
- GPH could be equipped with tubing leak sensor
- Both GPH and LPH are designed with open head sensor for enhanced operator safety

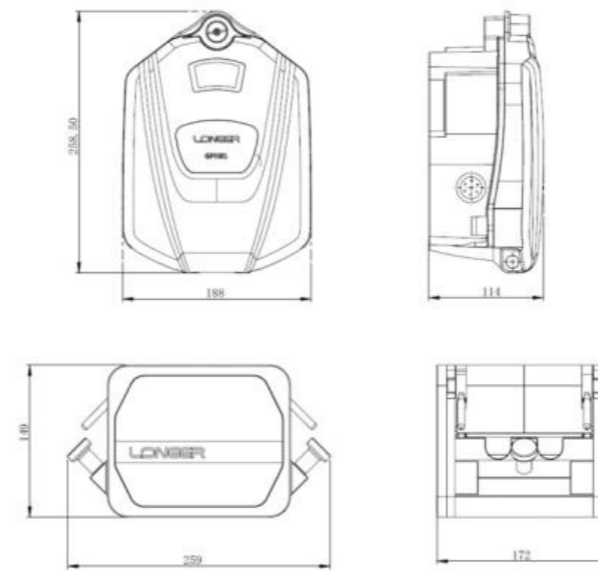

LPH with double tubing assembly for low pulsation pumping

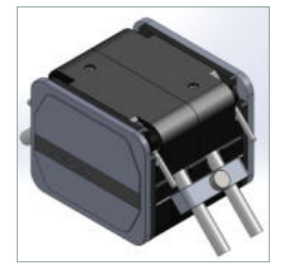

LPH with continuous tubing for double channel pumping



Double tubing assembly for LPH



Tubing fitting assembly for GPH

Model	Product Code	Roller Number	Roller Material	Housing Material	Speed (rpm)	Tubing ID x Wall Thickness (mm)	Reference Max. Flow Rate (L/min)	Weight (Kg)
GPH01	05.01.70A	2	304sst	Die-cast aluminum	≤ 265 rpm	26# (6.4x3.3)	3.0	4.1
						73# (9.5x3.3)	6.0	
						82# (12.7x3.3)	10.5	
						184# (15.9x3.3)	15.0	
GPH02	05.01.71A	2	304sst	Die-cast aluminum		186# (12x4)	9.5	4.0
						188# (17x4)	17.0	
GPH03	05.01.71B	4	304sst	Die-cast aluminum		186# (12x4)	8.5	4.7
						188# (17x4)	14.0	
LPH01	05.01.72A	6	304sst	Anodized aluminum		185# (8x4)	4.5 (double tube assembly)	8.6
						186# (12x4)	9 (double tube assembly)	
						187# (16x4)	13.5 (double tube assembly)	

dPOFLEX® High Precise Filling Pump Head

PFH01, PFH02



- Small footprint, compact structure
- Anodised aluminum housing for good corrosion
- Precise filling of micro-volumes as low as 30uL with accuracy better than $\pm 1\%$
- Phase compensation structure for low pulse performance

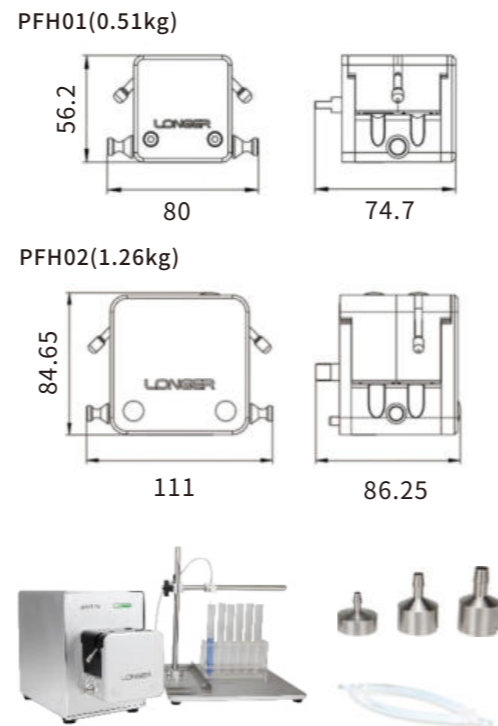
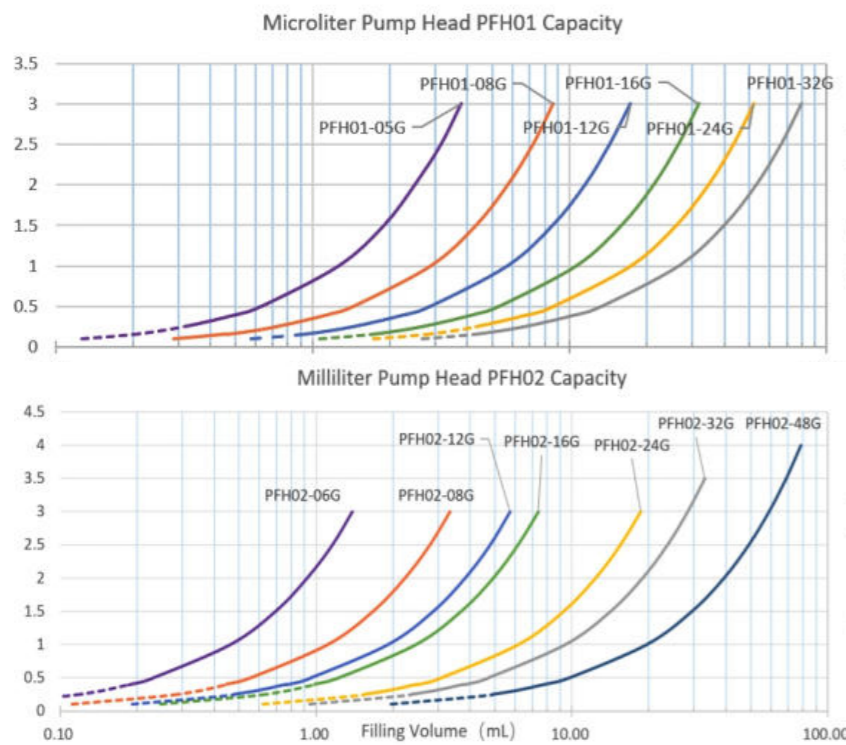

Pump Head Model	Roller Material	Roller Number	Speed (rpm)	Tubing ID (mm)	Max Flow Rate (mL/min)	Recommended Filling Volume (Accuracy $\leq \pm 1\%$)	Max Filling Volume per Second	Recommended Filling Nozzle ID (mm)
PFH01	Stainless Steel	12	≤ 350	0.5	7	30uL	118uL	0.3 or 0.6
				0.8	17	42uL	269uL	0.6
				1.2	34	90uL	534uL	1
				1.6	63	132uL	987uL	1 or 0.6
				2.4	104	400uL	1.61mL	1.6
PFH02	Stainless Steel	8	≤ 450	3.2	159	760uL	2.47mL	1.6 or 3.2
				0.6	27	0.2mL	0.42mL	0.6
				0.8	66	0.4mL	1.03mL	0.6
				1.2	114	0.5mL	1.78mL	1
				1.6	147	0.8mL	2.29mL	1 or 1.6
				2.4	371	1.16mL	5.77mL	1.6
				3.2	566	2.15mL	8.80mL	1.6 or 3.2
4.8	1178	3mL	18.28mL	3.2 or 4.5				

Small Flow, Low Pulse, Dispensing Pump Head

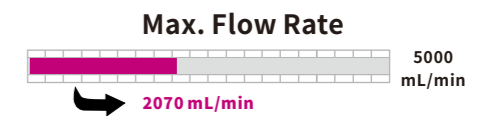

DMD15-13



- Special tubing assembly, low pulse, high accuracy.
- Designed for high precision and small volume dispensing.
- Compact size, easy to use.

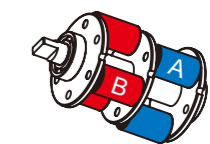
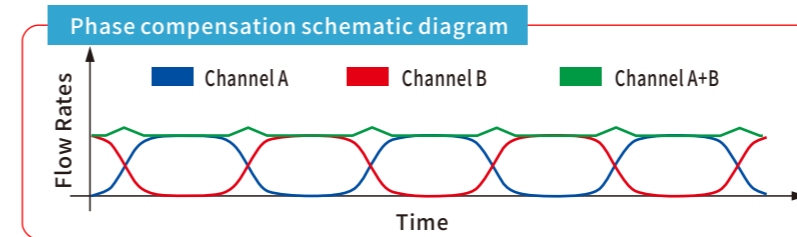
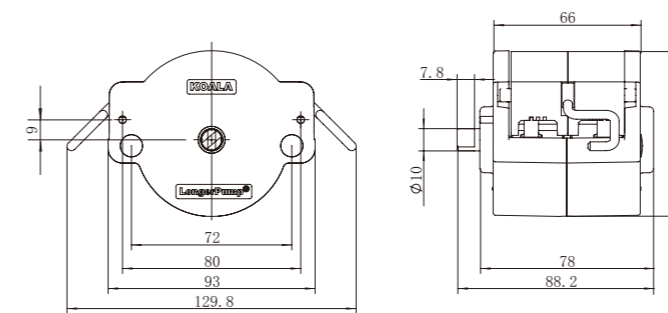

Phase compensation structure diagram

Model (Product Code, Housing Material)	Roller Material	Roller Number	Speed (rpm)	Tubing	Max. Flow Rate (mL/min)	Ref. Dispensing Volume (mL)	Ref. Dispensing Time(s)	Precision	Dispensing Head ID (mm)	Weight (kg)
DMD15-13-B(05.01.04B, PESU) DMD15-13-D(05.01.04D, PPS)	Stainless Steel	3	≤ 600	2x13 ⁺	80	>0.8	>0.6	$\pm 2\%$	≤ 0.5	0.43
						>1.6	>1.2	$\pm 1\%$	≤ 0.5	
				2x14 ⁺	300	>3	>0.6	$\pm 2\%$	≤ 1.0	
						>6	>1.2	$\pm 1\%$	≤ 1.0	
				2x19 ⁺	620	>6.2	>0.6	$\pm 2\%$	≤ 1.5	
						>12.4	>1.2	$\pm 1\%$	≤ 1.5	
2x16 ⁺	960	>9.6	>0.6	$\pm 2\%$	≤ 2.0					
		>19.2	>1.2	$\pm 1\%$	≤ 2.0					
2x25 ⁺	2070	>20.7	>0.6	$\pm 2\%$	≤ 3.0					
		>41.4	>1.2	$\pm 1\%$	≤ 3.0					

Intelligent Peristaltic Pump

L100-1F, L300-1F, L600-1F

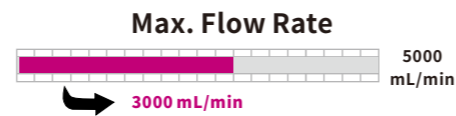

- 7 inch color display, full touch screen and intuitive graphic interface, provide easy-to-use operations
- Customize parameters by programming, and the parameter methods can be stored and easily recalled
- Multiple function modules and intelligent algorithms are designed for a wide variety of applications, including routine and multi-step complex applications
- Pump can be controlled through touch screen, foot switch, analog signal and communication commands, combined with a variety of interfaces (USB, RJ11, DB9 etc.) for easy system connection



Parameter Program Configuration

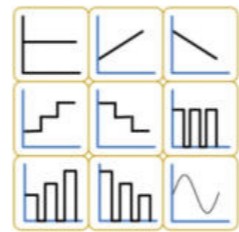

Running Control Module

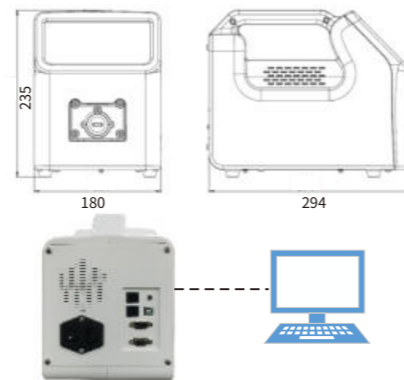

Upgrade the pump software through PC

	L100-1F	L300-1F	L600-1F
Speed	≤100rpm, CW/CCW	≤300rpm, CW/CCW	≤600rpm, CW/CCW
Speed resolution	0.1rpm	0.1rpm resolution when speed <100rpm, 1rpm resolution when speed ≥100rpm	
Flow rate	0.15uL/min-500ml/min	0.15uL/min-1500mL/min	0.15uL/min-3000mL/min
Dispensing volume	0.1mL-9999L(accuracy of ±2% with calibration)		
Calibration	Improve the flow rate and dispensing volume accuracy.		
Display	7Inch 1024×600 color LCD		
Language	Chinese or English, set as needed		
Control mode	Touch screen control, footswitch control, external signal control and communication control		
Work mode	Programming		
Programming function	Running control module: constant, ramp up/down, stepped up/down, sine, constant dispensing, incremental/decremental dispensing. Logic control module: direction, delay, event trigger, status output, pause, jump, loop, stop. Configure multi-step program with multiple modules for complex application		
External control	Start/stop control, direction control: logic level signal or switch signal(dry contact) Speed control: 0-5V, 0-10V, 4-20mA or 0-10kHz with uniform interface, max speed can be set.		
Communication control	USB or RS485(RJ11) interface, Modbus protocol, multiple baud rate (1200/ 2400/ 4800/ 9600/ 19200/ 38400bps)		
Status output	Output logic level signals to indicate pump running status, direction status, and other custom status.		
Parameter method function	7 parameter methods can be stored and easily recalled, 1 external control method is preset		
Scheduled start	The delay start time can be set, and the pump will start running at desired time.		
Back suction	Antidrip through setting back suction angle and delay time for high dispensing accuracy		
Dispensing volume setting range	0.001uL-9999L		
Dispensing time and Interval time	0.5s-9000s		
Dispensing cycle	1-999999(0 for unlimited)		
Time in fluid transferring modules	1s-9000s (0s for continuous transfer without time limit)		
Delay time setting range	0.5s-9000s		
Prime	Fast filling and emptying at full speed		
EMC	Comply with EN 61326-1:2013		
Dimension (L×W×H)	294×180×235(mm)		
Power Supply	L100-1F-A/L300-1F-A: AC220V±20%, 50Hz/60Hz L100-1F-B/L300-1F-B: AC110V±20%, 50Hz/60Hz		AC100V-240V, 50Hz/60Hz
Power Consumption	35W	55W	100W
Condition	temperature: 0°C-40°C relative humidity: <80%		
IP rating	IP31		
Weight	5.0kg		

Pump Head	Tubing	Max Flow Rate Reference (mL/min)			Weight(kg)
		L100-1F	L300-1F	L600-1F	
YZ1515x, YZ1115	13", 14", 19", 16", 25", 17", 18"	380	1100	2200	5.4
YZ2515x	15", 24"	266	800	1600	5.4
YZ1125	15", 24", 35", 36"	500	1500	3000	5.4
FG15-13	13", 14", 19", 16", 25", 17", 18"	430	1200	2400	5.3
FG25-13	15", 24"	270	1100	2200	5.3
DMD15-13-B	2×13", 2×14", 2×19", 2×16", 2×25"	375	1035	2070	5.4
BZ15-13-A	14"	22	75	150	5.3
BZ15-13-B	16"	80	230	460	5.3
BZ15-13-C	25"	150	480	960	5.3
BZ15-13-D	17"	270	800	1600	5.3
BZ25-13-B	24"	250	800	1600	5.3
DG15-24	16", 25", 17"	300(Single Channel)	900(Single Channel)	1800(Single Channel)	5.8
DG15-28	13", 14", ID≤3.17mm, Wall thickness: 1mm	75(Single Channel, speed≤100rpm)			5.7
DG-(1,2,4,6,8)6rollers	ID≤3.17mm, Wall thickness: 0.8-1mm	48(Single Channel, speed≤100rpm)			5.2-5.6
DG-(1,2,4)10rollers	ID≤3.17mm, Wall thickness: 0.8-1mm	32(Single Channel, speed≤100rpm)			5.2-5.4

Intelligent Peristaltic Pump

L100-1FS, L300-1FS, L600-1FS

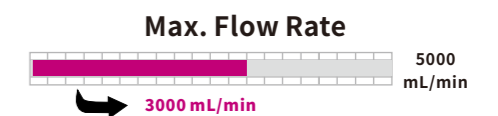

- Automatic identification of pump head and tubing, simplify the operation process and provide reliable guarantee for high-precision fluid transferring
- 7 inch color display, full touch screen and intuitive graphic interface, provide easy-to-use operations
- Customize parameters by programming, and the parameter methods can be stored and easily recalled
- Multiple function modules and intelligent algorithms are designed for a wide variety of applications, including routine and multi-step complex applications

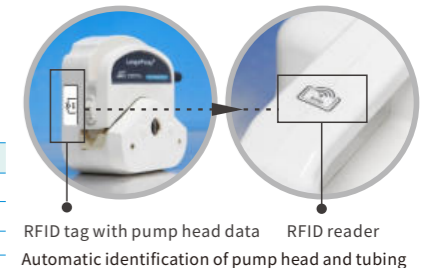

Automatic identification of pump head and tubing

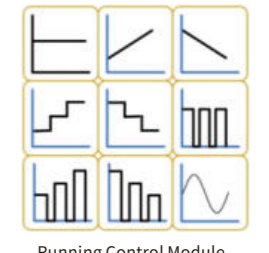

Running Control Module

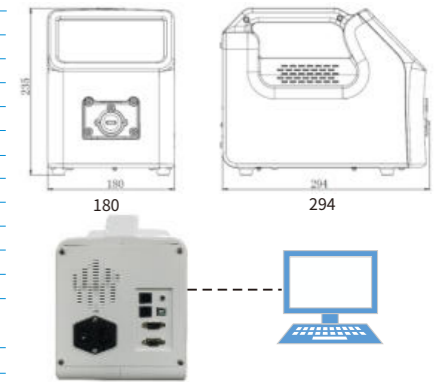

Upgrade the pump software through PC

	L100-1FS	L300-1FS	L600-1FS
Speed	≤100rpm, CW/CCW	≤300rpm, CW/CCW	≤600rpm, CW/CCW
Speed resolution	0.1rpm	0.1rpm resolution when speed <100rpm, 1rpm resolution when speed ≥100rpm	
Flow rate	0.15uL/min-500ml/min	0.15uL/min-1500mL/min	0.15uL/min-3000mL/min
Dispensing volume	0.1mL-9999L(accuracy of ±2% with calibration)		
Calibration	Improve the flow rate and dispensing volume accuracy.		
Display	7Inch 1024×600 color LCD		
Language	Chinese or English, set as needed		
Control mode	Touch screen control, footswitch control, external signal control and communication control		
Work mode	Programming		
Programming function	Running control module: constant, ramp up/down, stepped up/down, sine, constant dispensing, incremental/decremental dispensing. Logic control module: direction, delay, event trigger, status output, pause, jump, loop, stop. Configure multi-step program with multiple modules for complex application		
External control	Start/stop control, direction control: logic level signal or switch signal(dry contact) Speed control: 0-5V, 0-10V, 4-20mA or 0-10kHz with uniform interface, max speed can be set.		
Communication control	USB or RS485(RJ11) interface, Modbus protocol, multiple baud rate (1200/ 2400/ 4800/ 9600/ 19200/ 38400bps)		
Status output	Output logic level signals to indicate pump running status, direction status, and other custom status.		
Parameter method function	7 parameter methods can be stored and easily recalled, 1 external control method is preset		
Scheduled start	The delay start time can be set, and the pump will start running at desired time.		
Back suction	Antidrip through setting back suction angle and delay time for high dispensing accuracy		
Dispensing volume setting range	0.001uL-9999L		
Dispensing time and Interval time	0.5s-9000s		
Dispensing cycle	1-999999(0 for unlimited)		
Time in fluid transferring modules	1s-9000s (0s for continuous transfer without time limit)		
Delay time setting range	0.5s-9000s		
Prime	Fast filling and emptying at full speed		
EMC	Comply with EN 61326-1:2013		
Dimension (L×W×H)	294×180×235(mm)		
Power supply	L100-1FS-A/L300-1FS-A: AC220V±20%, 50Hz/60Hz L100-1FS-B/L300-1FS-B: AC110V±20%, 50Hz/60Hz		AC100V-240V, 50Hz/60Hz
Power Consumption	35W	55W	100W
Condition	Operating temperature: 0°C-40°C Relative humidity: <80%		
IP rating	IP31		
Weight	5.0kg		

Pump Head	Tubing	Max Flow Rate Reference (mL/min)			Weight(kg)
		L100-1FS	L300-1FS	L600-1FS	
YZ1515x, YZ1115	13", 14", 19", 16", 25", 17", 18"	380	1100	2200	5.4
YZ2515x	15", 24"	266	800	1600	5.4
YZ1125	15", 24", 35", 36"	500	1500	3000	5.4
FG15-13	13", 14", 19", 16", 25", 17", 18"	430	1200	2400	5.3
FG25-13	15", 24"	270	1100	2200	5.3
DMD15-13-B	2×13", 2×14", 2×19", 2×16", 2×25"	375	1035	2070	5.4
BZ15-13-A	14"	22	75	150	5.3
BZ15-13-B	16"	80	230	460	5.3
BZ15-13-C	25"	150	480	960	5.3
BZ15-13-D	17"	270	800	1600	5.3
BZ25-13-B	24"	250	800	1600	5.3
DG15-24	16", 25", 17"	300(Single Channel)	900(Single Channel)	1800(Single Channel)	5.8
DG15-28	13", 14", ID≤3.17mm, Wall thickness: 1mm	75(Single Channel, speed≤100rpm)			5.7
DG-(1,2,4,6,8)6rollers	ID≤3.17mm, Wall thickness: 0.8-1mm	48(Single Channel, speed≤100rpm)			5.2-5.6
DG-(1,2,4)10rollers	ID≤3.17mm, Wall thickness: 0.8-1mm	32(Single Channel, speed≤100rpm)			5.2-5.4

Basic Peristaltic Pump

L100-1E



Professional Assistant in Your Lab
With a variety of color options

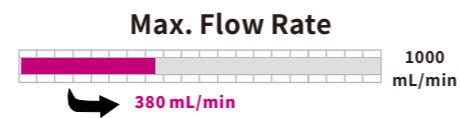

Compact Structure, small-foot print, save more space on your benchtop. Concise function, easy operation, improve work efficiency. Low vibration, low noise, offer a quiet and comfortable lab environment. Metal housing with anti-corrosion paint treatment, prolong pump life time. Good electromagnetic compatibility, ensure stable and reliable operation.

Pump Head Options



Speed	0.1rpm-100rpm, CW/CCW
Speed resolution	0.1rpm
Display	5-digit LED display for current speed, direction and run/stop status
Control Mode	Keypad control with physical buttons
Speed adjust function	Increase or decrease pump speed through physical buttons, and the automatic function is more convenient for speed adjustment
Prime	Fast filling or emptying at full speed
Power-off memory	Return to previous status when power on
EMC	Comply with EMC Directive 2014/30/EU
Dimension(L×W×H)	197mm×110mm×106mm
Power supply	AC 100V~240V (15W), 50~60Hz
Operating temperature	0°C~40°C
Relative humidity	<80%
IP rating	IP31
Weight	2.44kg

Model (Product Code, Color)	Pump Head	Tubing	Max. Flow Rate (mL/min)	Weight(kg)
L100-1E-D (05.02.43A,White)	YZ1515x, YZII15	13" 14" 19" 16" 25" 17" 18"	380	2.84
	YZ2515x, YZII25	15" 24"	270	
L100-1E-E (05.02.43B,Orange)	DMD15-13-B	2×13" 2×14" 2×19"	350	2.87
	DMD15-13-D	2×16" 2×25"		
L100-1E-F (05.02.43C,Silver Grey)	BZ15-13-A	14"	20	2.75
	BZ15-13-B	16"	77	
	BZ15-13-C	25"	160	
	BZ15-13-D	17"	300	
	BZ25-13-B	24"	300	
	DG-(1,2)6 Rollers	ID≤3.17mm	48(Single Channel)	
DG-(1,2)10 Rollers	Wall Thickness 0.8-1mm	32(Single Channel)		

Basic Peristaltic Pump

BT100-3J

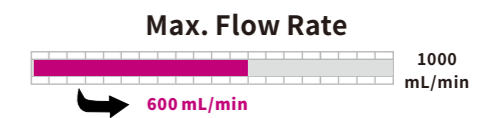

Speed	0.1rpm-100rpm, CW/CCW.
Speed resolution	0.1rpm
Control mode	Membrane keypad, external signal control and communication control are available
Display	3-digit LED display for current speed, 3 LED indicators for operating status
External control	Start/stop, direction and speed control (4-20mA, 0-5V, 0-10V, 0-10kHz external control module optional)
Communication interface	RS485
Power-off memory	Return to previous status when powered on
Prime	For fast filling and emptying at full speed
Dimension (L×W×H)	232×142×149 (mm)
Power supply	AC 100V-240V 50/60Hz
Operating temperature	0 to 40°C
Relative humidity	<80%
IP rating	IP20
Weight	2.3kg



Pump Head Options



Commonly used in
laboratorial applications

Model	Product Code	Pump Head	Tubing	Max. Flow Rate (mL/min)
BT100-3J	05.02.11B	YZ1515x(3 rollers), YZII15	13" 14" 19" 16" 25" 17" 18"	380
		YZ2515x, YZII25	15" 24"	270
		DMD15-13-B, DMD15-13-D	2×13", 2×14", 2×19", 2×16", 2×25"	350
		BZ15-13-A	14"	22
		BZ15-13-B	16"	80
		BZ15-13-C	25"	150
		BZ15-13-D	17"	270
		BZ25-13-B	24"	250
		DG-1, DG-2, DG-4(6 rollers)	ID≤3.17mm, Wall Thickness 0.8-1mm	48 (Single Channel)
		DG-1, DG-2, DG-4(10 rollers)		32 (Single Channel)
		DG15-24	16", 25", 17"	300 (Single Channel)
		DG15-28	ID≤3.17mm, Wall Thickness 1mm	75 (Single Channel)
	13", 14"	75 (Single Channel)		

Basic Peristaltic Pump

BT300-2J/ BT600-2J

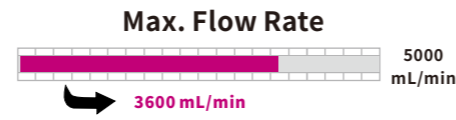

Mainly used in laboratorial applications.
Higher speed and flow rate than BT100-3J.

Pump Head Options



	BT300-2J	BT600-2J
Speed	1rpm-300rpm, CW/CCW	1rpm-600rpm, CW/CCW
Speed resolution	1rpm	
Control mode	Control panel, external signal control and communication control are available	
Display	3-digit LED display for current speed	
External control	Start/stop, direction and speed control (4-20mA, 0-5V, 0-10V, 0-10kHz External control module optional)	
Communication interface	RS485	
Power-off memory	Return to previous status when powered on	
Prime	For fast filling and emptying at full speed	
Dimension (L×W×H)	285×207×180 (mm)	
Power supply	AC 90V-260V/48W	AC 90V-260V/100W
Operating temperature	0 to 40°C	
Relative humidity	<80%	
IP rating	IP31	
Weight	3.6kg	3.8kg



Model	Product Code	Pump Head	Tubing	Max. Flow Rate (mL/min)	Weight (kg)
BT300-2J	05.02.31A	YZ1515x, YZII15	13" 14" 19" 16" 25" 17" 18"	1140	4.0
		YZ2515x	15" 24"	840	
		YZII25	15" 24" 35" 36"	1500	
		DG15-24	16" 25" 17"	900 (Single Channel)	
BT600-2J	05.02.62A	YZ1515x, YZII15	13" 14" 19" 16" 25" 17" 18"	2200	4.2
		YZ2515x	15" 24"	1600	
		YZII25	15" 24" 35" 36"	3000	
		DG15-24	16" 25" 17"	1800 (Single Channel)	

Basic Peristaltic Pump

WT600-2J

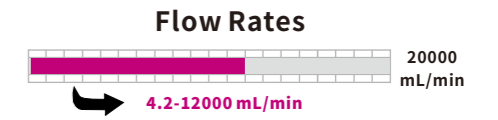

Pump Head Options



Speed	60rpm-600rpm, CW/CCW.
Speed resolution	1rpm
Speed accuracy	≤±1%
Control mode	Control panel, external signal control and communication control are available.
Display	3-digit LED display for current speed
External control	Start/stop, direction and speed control (4-20mA, 0.5-5V, 1-10V, 1-10kHz external control module optional).
Communication interface	RS485
Power-off memory	Return to previous status when powered on
Prime	For fast filling and emptying at full speed
Dimension (L×W×H)	285×207×180 (mm)
Power supply	AC 220V±20%/200W or AC 110V±20%/200W
Operating temperature	0 to 40°C
Relative humidity	<80%
IP rating	IP31
Weight	5.2kg

Mainly used in laboratorial applications. With brushless motor, can drive multi-pump heads.

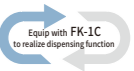

Model (Product code, Power supply)	Pump Head	Tubing	Flow Rate (mL/min)	Weight (kg)
WT600-2J-A (05.02.63A, AC220V)	(1, 2, 3, 4)×YZ1515x	13" 14" 19" 16" 25" 17" 18"	4-2200 (Single Channel)	5.6-6.8
	(1, 2, 3, 4)×YZII15			
WT600-2J-B (05.02.63B, AC110V)	(1, 2, 3, 4)×YZ2515x	15" 24"	100-1600 (Single Channel)	5.6-6.0
	(1, 2)×YZII25	15" 24" 35" 36"	100-3000 (Single Channel)	
	DG15-24	16" 25" 17"	50-1800 (Single Channel)	
	(1, 2)×KZ25	15" 24" 35" 36"	200-6000 (Single Channel)	6.0-6.8

Basic Peristaltic Pump

WT600-3J

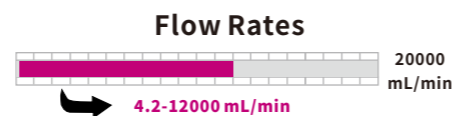

Mainly used in industrial applications. With brushless motor, can drive multi-pump heads. Stainless steel housing, high IP rating.



Speed	60rpm-600rpm, CW/CCW
Speed resolution	1rpm
Speed accuracy	≤ ±1%
Control mode	Membrane keypad, external signal control and communication control are available
Display	3-digit LED display for current speed, 4 LED indicators for operating status
External control	Start/stop, direction and speed control (4-20mA, 0.5-5V, 1-10V, 1-10kHz external control module optional)
Communication interface	RS485
Power-off memory	Return to previous status when powered on
Prime	For fast filling and emptying at full speed
Dimension (L×W×H)	273×190×272 (mm)
Power supply	AC 220V±20%/200W or AC 110V±20%/200W
Operating temperature	0 to 40°C
Relative humidity	<90%
IP rating	IP55
Weight	7.3kg

Model (Product code, Power supply, Speed control signal)	Pump Head	Tubing	Flow Rate (mL/min)	Weight (kg)
WT600-3J-A (05.02.64A, AC220V, 0.5-5V) WT600-3J-B (05.02.64B, AC220V, 1-10V) WT600-3J-C (05.02.64C, AC220V, 4-20mA)	(1, 2, 3, 4) × YZ1515x	13" 14" 19" 16"	4-2200 (Single Channel)	7.7-8.9
	(1, 2, 3, 4) × YZII15	25" 17" 18"		
WT600-3J-D (05.02.64D, AC220V, 1kHz-10kHz) WT600-3J-E (05.02.64E, AC220V, RS485)	(1, 2, 3, 4) × YZ2515x	15" 24"	100-1600 (Single Channel)	
WT600-3J-F (05.02.64F, AC110V, 0.5-5V) WT600-3J-G (05.02.64G, AC110V, 1-10V) WT600-3J-H (05.02.64H, AC110V, 4-20mA)	(1, 2) × YZII25	15" 24" 35" 36"	100-3000 (Single Channel)	7.7-8.1
WT600-3J-I (05.02.64I, AC110V, 1-10V) WT600-3J-J (05.02.64J, AC110V, 1kHz-10kHz) WT600-3J-K (05.02.64K, AC110V, RS485)	DG15-24	16" 25" 17"	50-1800 (Single Channel)	8.1
	(1, 2) × KZ25	15" 24" 35" 36"	200-6000 (Single Channel)	8.1-8.9

Basic Peristaltic Pump

YT600-1J

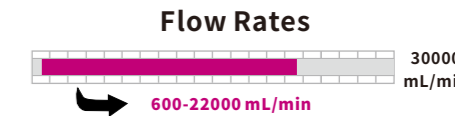

Mainly used in industrial applications. With DC motor, can drive multi-pump heads. Stainless steel housing, high IP rating.



Speed	60rpm-600rpm, CW/CCW
Control mode	Control panel and external signal control are available
External control	Start/stop, speed control (4-20mA, 1-10V, 1-10kHz external control mode optional)
Dimension (L×W×H)	380×326×214 (mm)
Power supply	AC 220V±20%/400W
Operating temperature	0 to 40°C
Relative humidity	<80%
IP rating	IP54
Weight	20kg

Model (Product code, Speed control signal)	Pump Head	Tubing	Flow Rate (mL/min)	Weight (kg)
YT600-1J-A (05.02.52A, 4-20mA)	(1, 2) × KZ35-13	73" 82"	600-11000 (Single Channel)	23.7-27.4
YT600-1J-B (05.02.52B, 1-10V)				
YT600-1J-C (05.02.52C, 1-10kHz)	(1, 2) × YZ35-13			21.6-23.2

Basic Peristaltic Pump

JL350-2J

Mainly used in industrial applications.
AC motor, frequency control, high IP rating.
Combine special convex rollers with concave compression block to run stably and prolong tubing life.

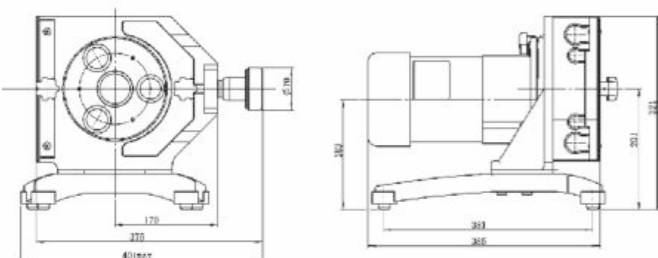

Fluid transferring in industrial applications

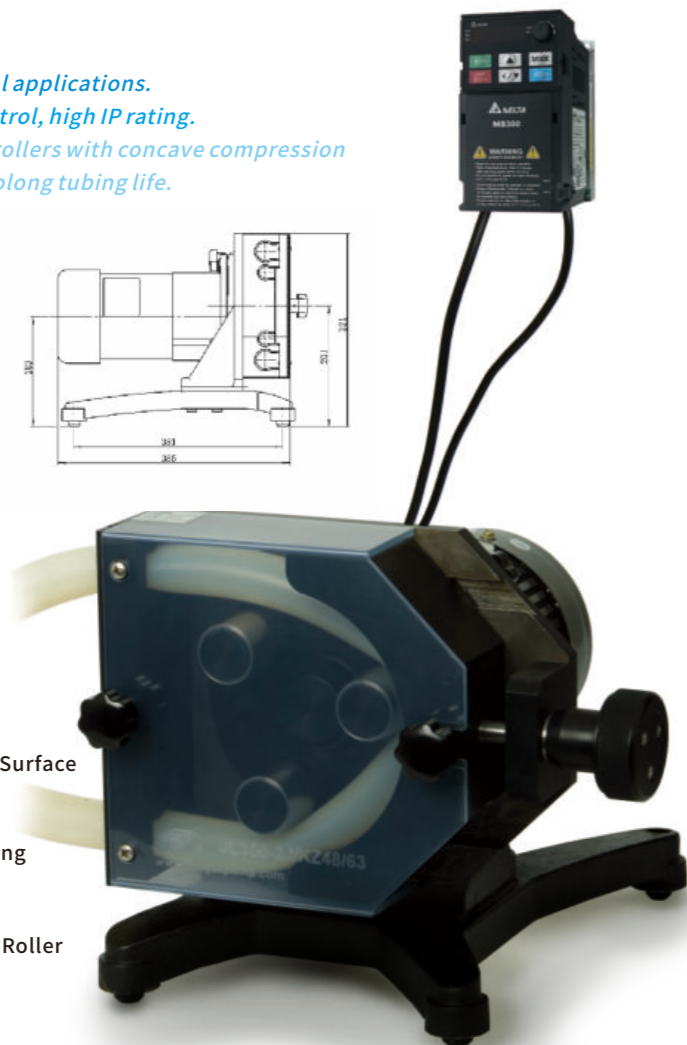
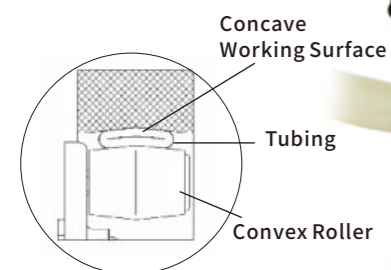

Speed	30rpm-350rpm, CW/CCW
Speed resolution	0.6rpm
Control mode	keypad control or external signal control
Display	LCD for running information
Speed control	0-5V, 0-10V, 4-20mA linear control
Start/stop signal input	Switch signal control
Direction signal input	Switch signal control
Communication function	RS485 interface, Modbus RTU protocol
Memory function	Storing the running parameter automatically
Dimension (L×W×H)	417×401×321 (mm)
Power supply	AC 220V±10%/400W
Operating temperature	0 to 40°C
Relative humidity	<80%
IP rating	IP55(excluding frequency converter)
Weight	32kg

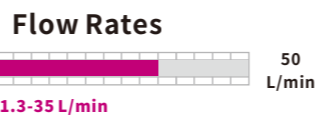

Tubing Loading

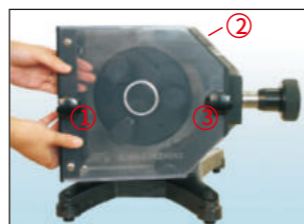

1. Turn the knob ①、② counter clockwise.
2. Turn the hand wheel to loose the compression block.
3. Pull the knob ③ and take off the front cover.



4. Select suitable tubing slots, place the tubing between the roller and the compression block, then put the tubing in the corresponding tubing slots.

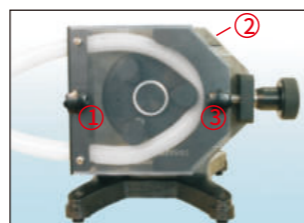

5. Pull the knob ③, insert the front cover, tighten the knob CW to fix the front cover ①.
6. Turn the hand wheel and adjust the occlusion between the roller and the compression block.
7. Tighten the knob ② and fix the compression block.



IP55

Tubing with fitting assembly

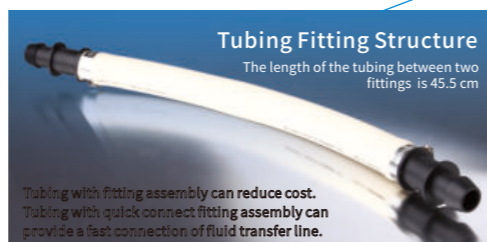

Tubing with fitting assembly can reduce cost. Tubing with quick connect fitting assembly can provide a fast connection of fluid transfer line.

Model	Product Code	Pump Head	Tubing	Flow Rate (L/min)	Weight (kg)
JL350-2J	05.02.34A	KZ48	88 [#]	1.3-15	32
			92 [#]	3-35	

Basic Peristaltic Pump

BQ50-1J

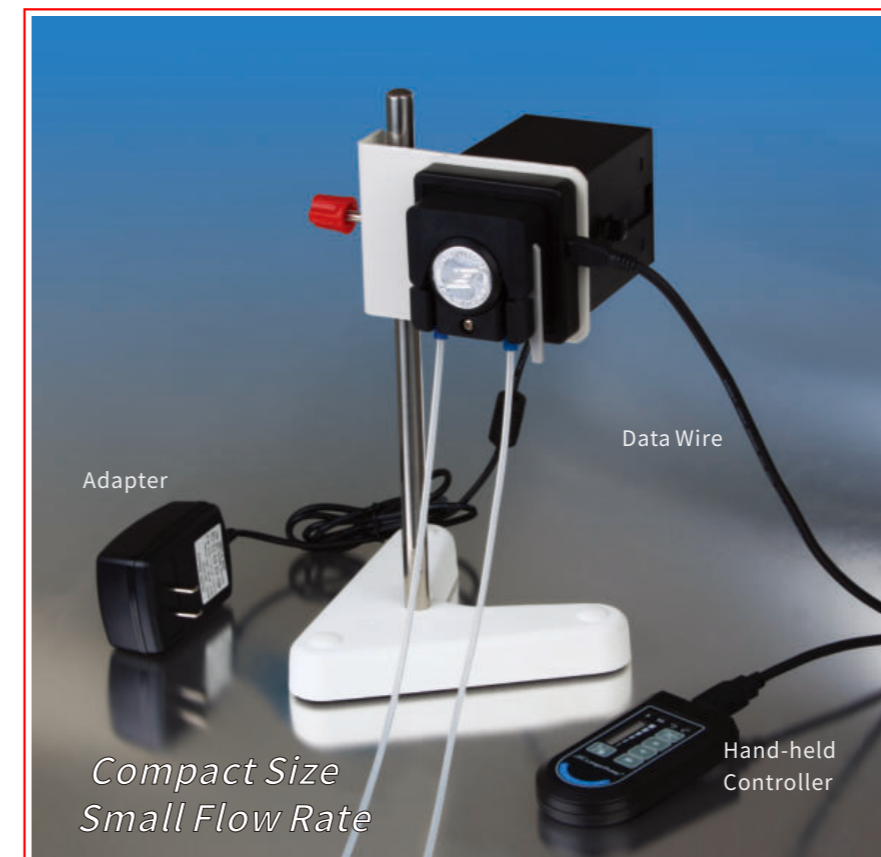
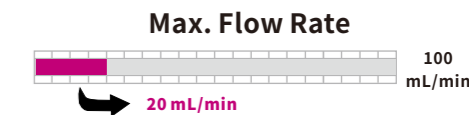

Speed	1rpm-50rpm, CW/CCW
Speed resolution	1rpm (manually control), 0.1rpm (external control)
Control mode	Hand-held controller, external signal control and communication control are available
Display	Hand-held controller displays speed and running status
External control	Start/stop, direction and speed control (4-20mA, 0-5V, 0-10V, 0-10kHz external control module optional)
Communication	RS485
Power-off memory	Return to previous status when powered on
Prime	For fast filling and emptying at full speed
Dimension (L×W×H)	135mm×72mm×72mm (drive + pump head) 105mm×50mm×16mm (hand-held controller)
Power supply	DC 12V/10W (pump) AC 90V-260V/10W (adapter)
Operating temperature	0 to 40°C
Relative humidity	<80%
IP rating	IP31
Weight	0.5kg
Standard configuration	Drive with pump head, hand-held controller, adapter, data wire
Optional accessories (Order separately)	Small V-base, polished stainless steel pole, fixing plate, specific tubing

Mainly used in laboratorial applications.
Embedded or rack-mounted.

Installation Drawing

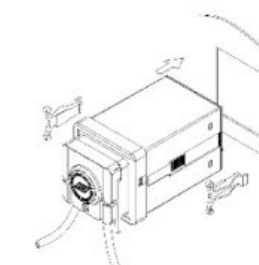

1. Insert pump into the mounting hole of user instrument.

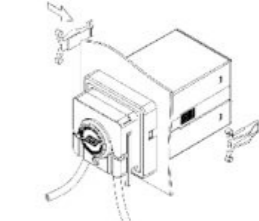

2. Insert the clips into the slots of the pump housing.

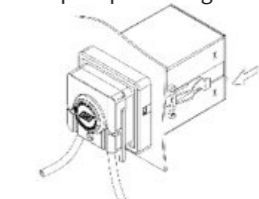

3. Push the clips and fix the pump in user instrument.



Model	Product Code	Color	Pump Head	Roller Number	Pump Head Material	Tubing	Max. Flow Rate (mL/min)	Weight (kg)
BQ50-1J-A	05.02.02A	Black	WX10-14-A	4	ABS, POM	ID ≤3.17 (mm) Wall Thickness 0.8-1 (mm)	20	0.5
BQ50-1J-B	05.02.02B		WX10-14-C		ABS, PVDF			
BQ50-1J-C	05.02.02C		WX10-18-A	ABS, POM				
BQ50-1J-D	05.02.02D		WX10-18-C	ABS, PVDF				

Standard Peristaltic Pump

L100-1S-2



* Product L100-1S-1 (product code:050241A) has same performance and parameters as L100-1S-2, but only can be controlled by keypad.

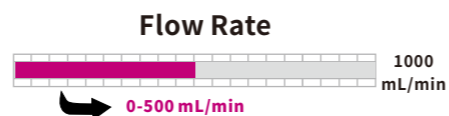

Mainly designed for Laboratory and light industry applications. With precise speed control in 0.01rpm resolution (10000:1 turndown ratio), and flow rate calibration function, the pump has more accurate and wider range of flow rate. With the intelligent fan control, the pump has lower noise and better energy efficiency. LCD with specially designed run screen displays parameters and running status, which provides enough information for correct operation.

Pump Head Options



Speed	0.01rpm-100rpm, CW/CCW
Speed resolution	0.01rpm resolution within the speed of 0.01rpm-10rpm 0.1rpm resolution within the speed of 10rpm-100rpm
Display	LCD
Control mode	Keypad control, external signal control and communication control
Work mode	Speed control mode and flow rate mode
Flow rate mode	Flow rate is displayed and the pump runs continuously at the set flow rate
Flow rate calibration	Improve the flow rate accuracy
Flow rate setting range	0.01μL/min-999L/min, unit could be set as μL/min, mL/min or L/min
External control	Start/stop control (switch signal), direction control (switch signal), speed control (0-5V, 0-10V, 4-20mA, 0-10kHz are optional with uniform interface, from 0-10rpm in 0.01rpm resolution, from 10-100rpm in 0.1rpm resolution)
Communication control	RS485 interface, Longer protocol or Modbus protocol, the communication parameters (address, baud rate, parity, stop bit) can be set through keypad
Timing function	Set the running time (13 options), the pump could run/stop automatically
Parameter memory	Operating parameters will be saved automatically
Status when powered up	The pump status when powered up could be set as stop or as the status before power loss
Prime	Fast filling or emptying at full speed
Keypad lock function	Keypad can be locked to prevent the misoperation. The delay time before lock is settable.
Dimension(L×W×H)	232×142×149(mm)
Power supply	AC100V-240V/25W, 50/60Hz
Operating temperature	0 to 40°C
Relative humidity	<80%
IP rating	IP31
Weight	2.38kg

Model (Product code)	Pump head	Tubing	Flow Rate Reference	Weight (kg)
L100-1S-2 (05.02.42A)	YZ1515x, YZ1115	13" 14" 19" 16" 25" 17" 18"	0.6μL/min - 380mL/min	2.78
	YZ215x	15" 24"	16μL/min - 270mL/min	
	YZ1125	15" 24" 35" 36"	16μL/min - 500mL/min	
	FG15-13	13" 14" 19" 16" 25" 17" 18"	0.5μL/min - 430mL/min	2.66
	FG25-13	15" 24"	22μL/min - 320mL/min	
	DMD15-13-B, DMD15-13-D	2×13" 2×14" 2×19" 2×16" 2×25"	2μL/min - 375mL/min	2.81
	BZ15-13-A	14"	3μL/min - 22mL/min	2.69
	BZ15-13-B	16"	8μL/min - 80mL/min	
	BZ15-13-C	25"	16μL/min - 150mL/min	
	BZ15-13-D	17"	27μL/min - 270mL/min	
BZ25-13-B	24"	27μL/min - 250mL/min		
DG15-24	16" 25" 17"	8μL/min - 300mL/min(Single channel)	3.2	
DG15-28	13" 14" ID≤3.17mm Wall Thickness 1mm	0.31μL/min - 75mL/min(Single channel)	3.05	
DG-(1,2,4,6,8)6 Rollers	ID≤3.17mm Wall Thickness 0.8-1mm	0.21μL/min - 48mL/min(Single channel)	2.58-3.01	
DG-(1,2,4)10 Rollers		0.15μL/min - 32mL/min(Single channel)		

Flow Rate Peristaltic Pump

LEAD-2

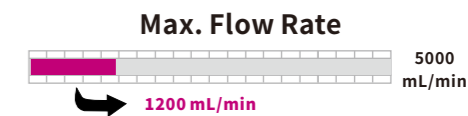

Mainly used in laboratorial applications. Top-mounted pump head.

Pump Head Options

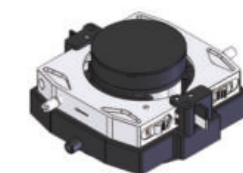

LEAD15-24 (2 channels, 4 rollers)

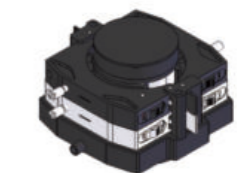

LEAD15-44 (4 channels, 4 rollers)

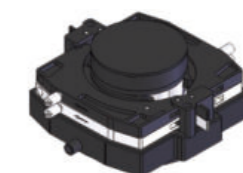

LEAD15-48 (4 channels, 8 rollers)

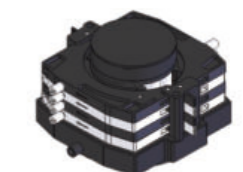

LEAD15-88 (8 channels, 8 rollers)

Speed	1rpm-100rpm, CW/CCW
Speed resolution	0.1rpm
Control mode	Control panel, external signal control and communication control are available
Display	128×32 graphic LCD for current running status
Calibration function	Improve flow rate accuracy
External control	Start/stop, direction and speed control (4-20mA, 0-5V, 0-10V, external control module optional)
Communication interface	RS485
Power-off memory	Return to previous status when powered on
Prime	For fast filling and emptying at full speed
Dimension (L×W×H)	190×162×275 (mm)
Power supply	AC 90V-260V/50W
Operating temperature	0 to 40°C
Relative humidity	<80%
IP rating	IP31
Weight	3.5kg

Model (Product code, Language)	Pump Head	Channel/rollers	Tubing	Max. Flow Rate (mL/min)	Weight (kg)
LEAD-2-A (05.02.19A, Chinese)	LEAD15-24	2/4	16" 25" 17"	300 (Single Channel)	4.36
	LEAD15-44	4/4			4.42
LEAD-2-C (05.02.19C, English)	LEAD15-48	4/8	13" 14" ID≤3.17 (mm) Wall Thickness 0.8-1 (mm)	75 (Single Channel)	4.48
	LEAD15-88	8/8			

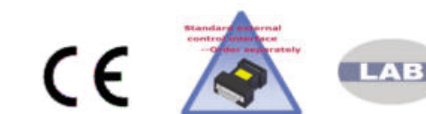

Flow Rate Peristaltic Pump

BT100-1L

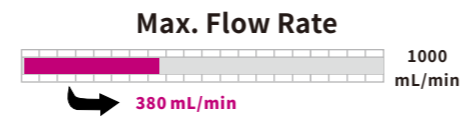

Pump Head Options



Mainly used in
laboratorial applications.
Can drive multi-pump heads.



Speed	0.1rpm-100rpm, CW/CCW
Speed resolution	0.1rpm
Control mode	Control panel, external signal control and communication control are available
Display	128×32 graphic LCD for current running status
Calibration function	Improve flow rate accuracy
External control	Start/stop, direction and speed control (4-20mA, 0-5V, 0-10V, external control module optional)
Communication interface	RS485
Power-off memory	Return to previous status when powered on
Prime	For fast filling and emptying at full speed
Dimension (L×W×H)	202×160×239 (mm)
Power supply	AC 110V±10%/50W or AC220V±10%/50W optional
Operating temperature	0 to 40°C
Relative humidity	<80%
IP rating	IP31
Weight	5.3kg

Model (Product code, Power supply)	Pump Head	Tubing	Max. Flow Rate (mL/min)	Weight (kg)
BT100-1L-A (05.02.12A, AC220V)	DG15-24	16" 25" 17"	300 (Single Channel)	6.1
	DG15-28	13" 14" ID ≤3.17 (mm)	75 (Single Channel)	5.9
	DG15-48	Wall Thickness 1 (mm)		
BT100-1L-B (05.02.12B, AC110V)	DG- (2, 4, 6, 8, 12, 16, 24) 6 Rollers	ID≤3.17 (mm)	48 (Single Channel)	5.7-8.6
	DG- (2, 4, 6, 8, 12, 16, 24) 10 Rollers	Wall Thickness 0.8-1 (mm)	32 (Single Channel)	
BT100-1L-B (05.02.12B, AC110V)	(1, 2, 3, 4)×YZ1515x	13" 14" 19" 16" 25" 17" 18"	380 (Single Channel)	5.7-6.9
	(1, 2, 3, 4)×YZII15			
	(1, 2, 3, 4)×YZ2515x	15" 24"	270 (Single Channel)	5.7-6.1
	(1, 2)×YZII25	15" 24" 35" 36"	500 (Single Channel)	
	(1, 2)×DMD15-13-B/DMD15-13-D	13" 14" 19" 16" 25"	350 (Single Channel)	

Dispensing Peristaltic Pump

BT100-1F

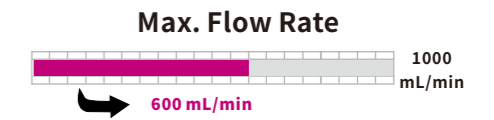

Mainly used in
laboratorial applications.

Pump Head Options



Speed	0.1rpm-100rpm, CW/CCW
Speed resolution	0.1rpm
Control mode	Control panel, external signal control and communication control are available
Display	LCD for running status
Work mode	Flowrate mode and dispensing mode
Flowrate calibration	Improve flow rate accuracy
Dispensing volume	0.01mL-9.99L
Dispensing calibration	Calibrate dispensing volume to improve accuracy
Copy number	1 to 9999, "0" means unlimited cycle
Pause time	0.1s-99.9min, resolution is 0.1s
Back suction time	0s-99.9s, resolution is 0.1s
External control	Start/stop, direction and speed control (4-20mA, 0-5V, 0-10V, 0-10kHz external control module optional)
Speed output	10Hz-10kHz corresponding to 0.1-100rpm
Start/stop output	OC gate signal
Direction output	OC gate signal
Communication interface	RS485
Power-off memory	Return to previous status when powered on
Prime	For fast filling and emptying at full speed
Dimension (L×W×H)	285×207×180 (mm)
Power supply	AC 90V-260V/40W
Operating temperature	0 to 40°C
Relative humidity	<80%
IP rating	IP31
Weight	3.8kg



Model (Product code, Language)	Pump Head	Tubing	Max. Flow Rate(mL/min)	Weight(kg)
BT100-1F (05.02.13A, Chinese)	YZ1515x, YZII15	13" 14" 19" 16" 25" 17" 18"	380	4.2
	YZ2515x	15" 24"	270	
	YZII25	15" 24" 35" 36"	500	
BT100-1F-B (05.02.13B, English)	DG- (1, 2, 4) 6 Rollers	ID≤3.17 (mm)	48	4-4.3
	DG- (1, 2, 4) 10 Rollers	Wall Thickness 0.8-1 (mm)	32	
	DMD15-13-B, DMD15-13-D	13" 14" 19" 16" 25"	350	4.2
	DG15-24	16" 25" 17"	300 (Single Channel)	4.6
	DG15-28	13" 14" ID ≤3.17 (mm) Wall Thickness 1 (mm)	75 (Single Channel)	4.5

Dispensing Peristaltic Pump

BT300-1F

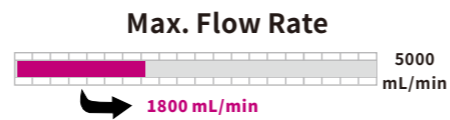

Mainly used in laboratorial applications.

Pump Head Options



YZ1515x
YZ2515x



YZII15
YZII25



DMD15-13-B
DMD15-13-D



DG15-24

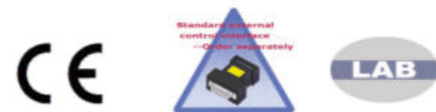

Speed	1rpm-300rpm, CW/CCW
Speed resolution	1rpm
Control mode	Control panel, external signal control and communication control are available
Display	LCD for running status
Work mode	Flowrate mode and dispensing mode
Flowrate calibration	Improve flow rate accuracy
Dispensing volume	0.1mL-99.9L
Dispensing calibration	Calibrate dispensing volume to improve accuracy
Copy number	1 to 999, "0" means unlimited cycle
Pause time	0.1s-999s (0.1s resolution within the time of 0.1s-100s, 1s resolution within the time of 100s-999s.)
Back suction angle	0-360°, resolution is 18°
External control	Start/stop, direction and speed control (4-20mA, 0-5V, 0-10V, external control module optional)
Speed output	0-5V corresponding to 1-300rpm
Start/stop output	OC gate signal
Direction output	OC gate signal
Communication interface	RS485
Power-off memory	Return to previous status when powered on
Prime	For fast filling and emptying at full speed
Dimension (L×W×H)	202×160×239 (mm)
Power supply	AC 220V±10%/50W or AC 110V±10%/50W
Operating temperature	0 to 40°C
Relative humidity	<80%
IP rating	IP31
Weight	4.3kg

Model (Product code, Power supply, Language)	Pump Head	Tubing	Max. Flow Rate(mL/min)	Weight(kg)
BT300-1F-A(05.02.32A, AC220V, Chinese)	YZ1515x, YZII15	13" 14" 19" 16" 25" 17" 18"	1140	4.7
	YZ2515x	15" 24"	840	
BT300-1F-B(05.02.32B, AC110V, Chinese)	YZII25	15" 24" 35" 36"	1500	4.7
BT300-1F-C(05.02.32C, AC220V, English)	DMD15-13-B, DMD15-13-D	13" 14" 19" 16" 25"	1040	
BT300-1F-D(05.02.32D, AC110V, English)	DG15-24	16" 25" 17"	900 (Single Channel)	5.1

Dispensing Peristaltic Pump

WT600-1F

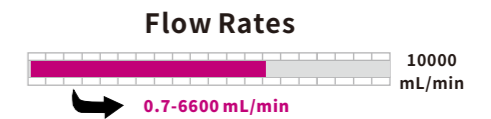

Mainly used in laboratorial applications.
With brushless motor, can drive multi-pump heads.

Pump Head Options



YZ1515x
YZ2515x



YZII15
YZII25



KZ25



DMD15-13-B
DMD15-13-D



DG15-24



Speed	10rpm-600rpm, CW/CCW
Speed resolution	1rpm
Control mode	Control panel, external signal control and communication control are available
Display	LCD for running status
Work mode	Flowrate mode and dispensing mode
Flowrate calibration	Improve flow rate accuracy
Dispensing volume	0.1mL-99.9L
Dispensing calibration	Calibrate dispensing volume to improve accuracy
Copy number	1 to 9999, "0" means unlimited cycle
Pause time	0.1s to 99.9min, resolution is 0.1s
Back suction circle	0 to 9.9 circle, resolution is 0.1 circle
External control	Start/stop, direction and speed control (4-20mA, 0-5V, 0-10V, 0-10kHz external control module optional)
Speed output	166.7Hz-10kHz corresponding to 10-600rpm
Start/stop output	OC gate signal
Direction output	OC gate signal
Communication interface	RS485
Power-off memory	Return to previous status when powered on
Prime	For fast filling and emptying at full speed
Dimension (L×W×H)	285×207×180 (mm)
Power supply	AC 220V±20%/140W or AC 110V±20%/140W
Operating temperature	0 to 40°C
Relative humidity	<80%
IP rating	IP31
Weight	5.2kg

Model (Product code, Power supply)	Pump Head	Tubing	Flow Rate(mL/min)	Weight(kg)
WT600-1F-A (05.02.65A, AC220V)	(1, 2, 3) × YZ1515x	13" 14" 19" 16" 25" 17" 18"	0.7-2200 (Single Channel)	5.6-6.4
	(1, 2, 3) × YZII15	15" 24"	17-1600 (Single Channel)	
WT600-1F-B (05.02.65B, AC110V)	(1, 2) × YZII25	15" 24" 35" 36"	17-3000 (Single Channel)	5.6-6.0
	DG15-24	16" 25" 17"	8-1800 (Single Channel)	
	(1, 2) × DMD15-13-B/DMD15-13-D	13" 14" 19" 16" 25"	1.5-2070 (Single Channel)	5.6-6.0
	KZ25	15" 24" 35" 36"	34-6000	

Dispensing Peristaltic Pump

WT600-4F

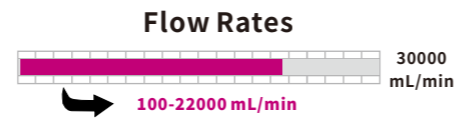

Mainly used in laboratorial and industrial applications. With brushless motor, can drive multi-pump heads. Aluminum alloy housing, high IP rating.

INDUSTRIAL

Pump Head Options



YZ35-13



KZ35

Speed	10rpm-600rpm, CW/CCW
Speed resolution	1rpm
Control mode	Control panel, external signal control and communication control are available
Display	LCD for running status
Work mode	Flowrate mode and dispensing mode
Flowrate calibration	Improve flow rate accuracy
Dispensing volume	100mL-999L
Dispensing calibration	Calibrate dispensing volume to improve accuracy
Copy number	1 to 9999, 0 means unlimited cycle
Pause time	0.1s to 99.9min, resolution is 0.1s
Back suction circle	0 to 9.9 circle, resolution is 0.1 circle
External control	Start/stop, direction and speed control (4-20mA, 0-5V, 0-10V, 0-10kHz external control module optional)
Speed output	125Hz-7.5kHz corresponding to 10-600rpm
Start/stop output	OC gate signal
Direction output	OC gate signal
Communication interface	RS485
Power-off memory	Return to previous status when powered on
Prime	For fast filling and emptying at full speed
Dimension (L×W×H)	360×215×243(mm)
Power supply	AC110V±20%/300W or AC220V±20%/300W
Operating temperature	0 to 40°C
Relative humidity	<100%
IP rating	IP65
Weight	12kg

Model (Product code, Power supply, Speed control signal)	Pump Head	Tubing	Flow Rate(mL/min)	Weight(kg)
WT600-4F-A (05.02.66A, AC220V, 0-5V) WT600-4F-B (05.02.66B, AC220V, 0-10V) WT600-4F-C (05.02.66C, AC220V, 4-20mA) WT600-4F-D (05.02.66D, AC220V, 0-10kHz) WT600-4F-E (05.02.66E, AC220V, RS485) WT600-4F-F (05.02.66F, AC110V, 0-5V) WT600-4F-G (05.02.66G, AC110V, 0-10V) WT600-4F-H (05.02.66H, AC110V, 4-20mA) WT600-4F-J (05.02.66J, AC110V, 0-10kHz) WT600-4F-K (05.02.66K, AC110V, RS485)	(1, 2)×YZ35-13-B	73" 82"	100-11000 (Single Channel)	13.65-15.3
	(1, 2)×KZ35-13-B			15.7-19.4

Industrial Peristaltic Pump

G100-2J

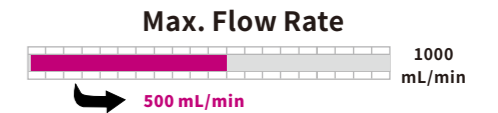

Speed	0rpm-100rpm, CW/CCW
Speed resolution	0.1rpm
Display	LCD
Control mode	Keypad control, external signal control and communication control are available
External control	Start/stop control, direction control: switch signal (dry contact) Speed control: 0-5V, 0-10V, 4-20mA, 0-10kHz are optional with uniform interface, max speed can be set between 10rpm and 100rpm
Communication control	RS485 interface, Longer Protocol or Modbus protocol, the communication parameters(baud rate, parity, stop bit) can be set through keypad
Parameter memory	Operating parameters will be saved automatically
Pump status when powered up	The pump status when powered up could be set as stop or as the status before power loss
Prime	Fast filling or emptying at full speed
EMC	Comply with EMC Directive 2014/30/EU
Keypad lock function	Keypad can be locked to prevent the misoperation
Dimension(L×W×H)	240×142×152(mm)
Power supply	AC90V-260V/20W, 50/60Hz
Operating temperature	0 to 40°C
Relative humidity	10%~90%
IP rating	IP 65
Weight	3.64kg

CE INDUSTRIAL

Using aluminium alloy housing with anti-corrosion paint treatment, the pump has good corrosive resistance and longer life time in corrosive environments. With good electromagnetic compatibility, the pump will not behave unacceptably in an EMI environment and will not interfere with other electronic equipment. Waterproof breathable design, enhanced sealing performance, IP65 protection for wet and dusty environment. Using high quality electronic components, optimized software design and circuit design, the pump provides long-term reliable and stable operation. LCD with specially designed run screen displays parameters and running status, which provides enough information for correct operation.

Pump Head Options

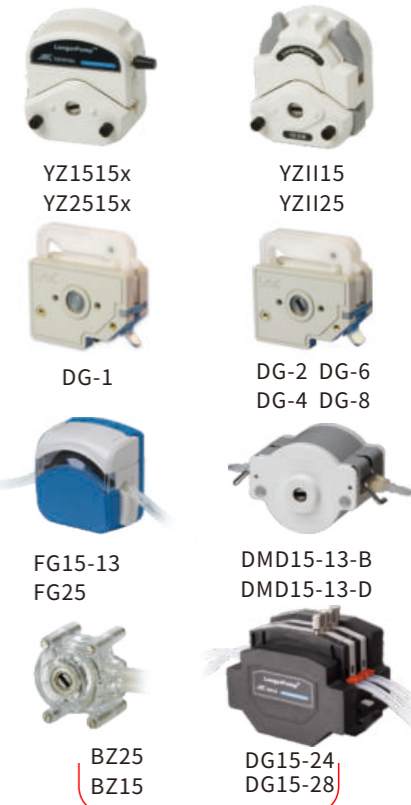

Model	Product Code	Pump Head	Tubing	Max. Flow Rate (mL/min)	Weight(kg)	
G100-2J	05.02.20B	YZ1515x, YZ1125	13" 14" 19" 16" 25" 17" 18"	380	4.04	
		YZ2515x	15" 24"	270		
		YZ1125	15" 24" 35" 36"	500		
		FG15-13-B		13" 14" 19" 16" 25" 17" 18"	430	3.92
		FG25-13-B		15" 24"	320	
		DMD15-13-B		2×13" 2×14" 2×19" 2×16" 2×25"	375	4.07
		DMD15-13-D				
		BZ15-13-A			14"	
		BZ15-13-B		16"	80	3.95
		BZ15-13-C		25"	150	
		BZ15-13-D		17"	270	
		BZ25-13-B		24"	250	
		DG15-24		16" 25" 17"	300(Single Channel)	
		DG15-28		13" 14" ID≤3.17mm Wall Thickness 1mm	75(Single Channel)	4.31
DG-(1,2,4,6,8)6 Rollers		ID≤3.17mm Wall Thickness 0.8-1mm	48(Single Channel)	3.84-3.91		
DG-(1,2,4)10 Rollers			32(Single Channel)			

Industrial Peristaltic Pump

G300-2J/G600-1J

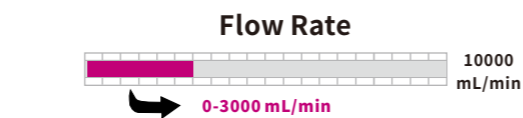

With good electromagnetic compatibility, the pump will not behave unacceptably in the EMI environment and will not interfere with other electronic equipment. Using aluminium alloy housing with anti-corrosion paint treatment, the pump has good corrosive resistance and longer life time in corrosive environment. Waterproof breathable design, enhanced sealing performance, IP65 protection for wet and dusty environment. LCD with specially designed run screen displays parameters and running status, which provides enough information for correct operation.

Pump Head Options



Specifications	Model	G300-2J	G600-1J
Speed Range		0rpm-300rpm, CW/CCW	0rpm-600rpm, CW/CCW
Speed resolution		1rpm	
Display		LCD	
Control mode		Keypad control, external signal control and communication control	
External control		Start/stop control, direction control: switch signal (dry contact). Speed control: 0-5V,0-10V,4-20mA,0-10kHz are optional with uniform interface, and max speed can be set.	
Max speed setting range in external control mode		30rpm-300rpm	60rpm-600rpm
Communication Control		RS485 interface, Longer protocol or Modbus protocol, the communication parameters (baud rate, parity, stop bit) can be set through keypad	
Parameter memory		Operating parameters will be saved automatically	
Pump state when power up		The pump state when power up could be set as stop or as the state before power loss	
Prime		Fast filling or emptying at full speed	
EMC		Comply with EMC Directive 2014/30/EU	
Keypad lock function		Keypad can be locked to prevent the misoperation	
Dimension(L x W x H)		240mm x 142mm x 152mm	240mm x 211mm x 155mm (including the external power supply and mounting bracket)
Power supply		AC100V-240V/60W, 50/60Hz	AC100V~240V/100W, 50/60Hz
Operating temperature		0°C~40°C	
Relative humidity		10%~90%	
IP rating		IP65	
Weight		3.64kg	5.56kg(including the external power supply and mounting bracket)

Pump Head	Tubing	Max Flow Rate Reference (mL/min)		Pump Head Weight(kg)
		G300-2J	G600-1J	
YZ1515x, YZ1115	13" 14" 19" 16" 25" 17" 18"	1140	2200	0.4
YZ2515x	15" 24" 35" 36"	1500	1600	0.4
YZ1125			3000	0.4
FG15-13	13" 14" 19" 16" 25" 17" 18"	1290	2400	0.28
FG25-13	15" 24"	960	2200	0.28
DMD15-13-B	2×13" 2×14" 2×19" 2×16" 2×25"	1125	2070	0.43
DMD15-13-D				
BZ15-13-A	14"	66	150	0.31
BZ15-13-B	16"	240	460	0.31
BZ15-13-C	25"	450	960	0.31
BZ15-13-D	17"	810	1600	0.31
BZ25-13-B	24"	810	1600	0.31
DG15-24	16" 25" 17"	900(single channel)	1800(single channel)	0.82

Industrial Peristaltic Pump

G300-3F

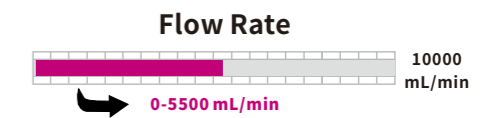

Industries have very wide demands for peristaltic pumps. But industry applications have more restrict requirements, such as higher IP rating, better chemical resistance, better reliability, and good electromagnetic compatibility. Longer Pump provides professional peristaltic pump solutions for industry applications, to meet the industrial fluid transferring and handling requirements.

- Using aluminium alloy housing with anti-corrosion paint treatment, the pump has good corrosive resistance and longer life time in corrosive environment.
- With good electromagnetic compatibility, the pump will not behave unacceptably in the EMI environment and will not interfere with other electronic equipment.
- With high IP rating, the pump could be used in wet and dusty environment.
- Using high quality electronic components, optimizing software design and circuit design, the pump provides long-term reliable and stable operation.
- With precise speed control in 0.1rpm resolution (3000:1 turndown ratio), and flow rate calibration function, the pump has more accurate flow rate.

Pump Head Options



Speed	0rpm-300rpm, CW/CCW
Speed Resolution	0.1rpm resolution within the speed of 0-100rpm 1rpm resolution within the speed of 100rpm-300rpm
Display	LCD
Control Mode	Keypad control, external signal control
Work Mode	Flow rate mode or dispensing mode
Flow rate mode	Flow rate is displayed and the pump runs continuously at the set flow rate
Flow rate calibration	Improve the flow rate accuracy
Flow rate setting range	1.000mL/min-9999mL/min
Dispensing mode	The pump dispenses continuously according to the parameters: dispensing volume, cycles, interval, back suction
Dispensing calibration	Improve the dispensing volume accuracy
Dispensing Volume	0.1mL-9999L
Dispensing cycle	0-9999
Interval time	1sec-99.9min
Back suction angle	0-180°, resolution is 36°
External control	Start/stop control, direction control: voltage level signal, 5V to 12V. Speed control: 0-5V.
Pump status output	1 OC gate signal for start/stop, 1 OC gate signal for direction. 0-4000Hz pulse signal for pump speed 0rpm-300rpm(linear function).
Power-off memory	Return to previous status when power on
Footswitch control	The pump could be start/stop controlled by footswitch accessory
Dimension(L×W×H)	360mm×215mm×243mm
Power Supply	AC220V±10%/120W, 50/60Hz
Operating Temperature	0 to 40°C
Relative humidity	<100%
IP rating	IP65
Weight	14kg

Model	Product code	Pump Head	Tubing	Max. Flow Rate (mL/min)	Weight(kg)
G300-3F	05.02.2CL	YZ35-13-B	73" 82"	5500	15.65
		KZ35-13-B			17.7

dPOFLEX® Peristaltic Pump

GP01, BP01

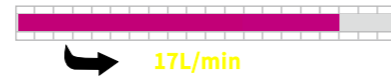

- Available in stainless steel housing and cast aluminum housing for variety of applications
- IP66 for wet and dusty environment
- Supporting fieldbus communication control, digital signal control, analog signal control, and pump status output
- Three-level user authority management, with electronic signature and audit trail functions, meet 21CFR Part 11 and GMP requirements
- Integrating multiple sensors: fluid leakage sensor, open-head sensor and flow rate sensor, to realize predictive maintenance

Pump drive model	dPOFLEX GP01	dPOFLEX BP01
Housing material	Cast aluminum	304sst
Speed range	0.1rpm-265rpm, CW/CCW	
Speed resolution	0.1rpm	
Display	4.3 inch LCD, Chinese or English	
Clock function	Year/month/day/hour/minute can be set, hours and minutes are displayed on the running screen	
Work mode	Flow rate mode, dispensing mode, calibration mode	
Flow rate mode	Pump runs continuously at the set flow rate, and displays flow rate and pump speed on the screen	
Flow rate setting range	1.1ml/min-17.0L/min (depending on pump head and tubing)	
Dispensing mode	Pump repeats the dispensing at set volume, cycles and interval time, and displays single volume, dispensed volume, dispensed cycles/target cycles on screen	
Volume of single dispense	1.0mL-274.9L (depending on pump head and tubing)	
Dispensing cycles	1-9999 (0 for unlimited)	
Interval time	5s-9999s	
Calibration function	Improve the flow rate and dispensing volume accuracy	
Control mode	Keypad control, external signal control and communication control	
Communication control	Standard:RS485 and Industrial Ethernet Interface, Modbus RTU and TCP/IP protocol Optional: Profibus DP	
External control	Speed control: 0-10V, 4-20mA start/stop, direction control: 5V-24V logic level signal or relay signal (dry contact)	
Status output	Pump Speed: 0-10V, 4-20mA, frequency signal Running/stop, direction, tubing leak alarm/other alarm: 3 relay signal (dry contact)	
Open head sensor	Pump will stop when pump head is open for enhanced user safety	
Status when power up	Stop	
Keypad lock function	Enable the keypad lock function to lock the keypad automatically after 20s standby, (start/stop key will not be locked)	
Tubing leak detection	Detect the tubing leak and give alarm (optional)	
Flow rate measurement	Measure the flow rate by connecting flow meter (optional)	
User access control	Three levels of user accesses (administrator, technician, operator)	
Electronic signature and audit trail	Meet the requirement of FDA 21CFR Part 11	
Log record	Record 90 days operation history, and can be exported directly	
3Q verification	IQ/OQ	
Certificate	CE, UKCAEN 61010-1:2010, EN IEC 61010-2-201; EMC: EN IEC61000-6-2, EN IEC 61000-6-4	
Deminsion(LxWxH)	260x407x298mm	260x407x290mm
Power supply	AC100-240V 50/60Hz,250W	
Operating condition	Temperature: 5°C-40°C, relative humidity≤100%	
IP rating	IP66	
Weight (drive only)	≤17.6kg	≤16.6kg

BP01+LPH01

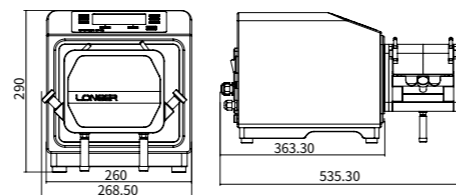

BP01+GPH01

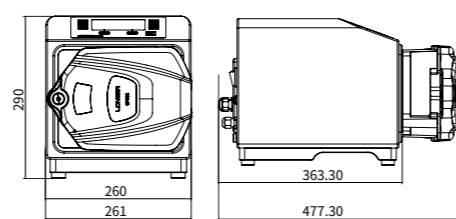

GP01+LPH01

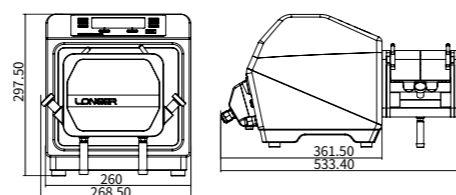

GP01+GPH01

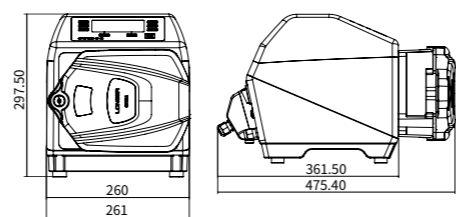

Model (Product Code)	Pump Head	Roller Number	Tubing	Reference Max. Flow Rate (L/min)
dPOFLEX GP01 (05.02.80A) dPOFLEX BP01 (05.02.81A)	GPH01	2	26#, 73#, 82#, 184#	15
	GPH02	2	186#, 188#	17
	GPH03	4	186#, 188#	14
	LPH01	6	185#, 186#, 187#	13.5

dPOFLEX® Explosion Proof Motor Pump

EP01

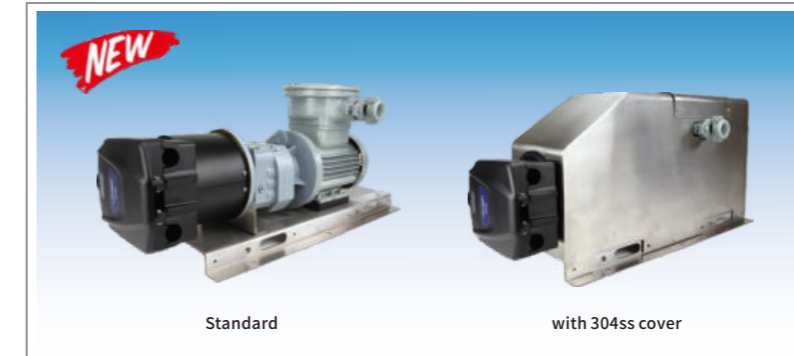

- Explosion proof motor
- Using frequency converter outside the hazardous location
- IP55 protection
- Explosion proof design pump heads with high flow rate up to 17L/min

Pump Drive	Pump speed	23rpm-265rpm
	Housing material	Cast iron (304ss protective cover is optional)
	Control mode	Frequency converter (to be used outside the hazardous location)
	Protection type	Ex d IIB T4 Gb
	Dimension (L*W*H)	765x300x400mm (without pump head)
	Power supply	3-phase AC 380V, 5Hz-60Hz
	Rated power	0.75kW
	Frequency range	5Hz-60Hz
	Working condition	5-40°C, relative humidity ≤90% RH
	IP rating	IP55
Frequency Converter (Optional)	Weight	60kg (without pump head and 304ss cover)
	1-phase converter	Model: VFD4A8MS21ANSAA, Input: 1-phase AC220V
	3-phase converter	Model: VFD2A7MS43ANSAA, Input: 3-phase AC380V
	Running direction	CW or CCW
	Speed resolution	0.01Hz (based on the output frequency resolution of the converter)
	Control mode	Keypad control, remote control and communication control
	Display	Segment LED display
	External control	Output frequency could be controlled by analog signal: 0-10V, 0-20mA, 4-20mA; Manual/remote control mode, pump running direction, pump start/stop, could be controlled by digital signal
	Status output	Output 0-20mA or 4-20mA to indicate the frequency to pump; Output relay signal to indicate pump status such as running/stop, direction or alarm
	Communication control	Rs485 interface, Modbus RTU protocol

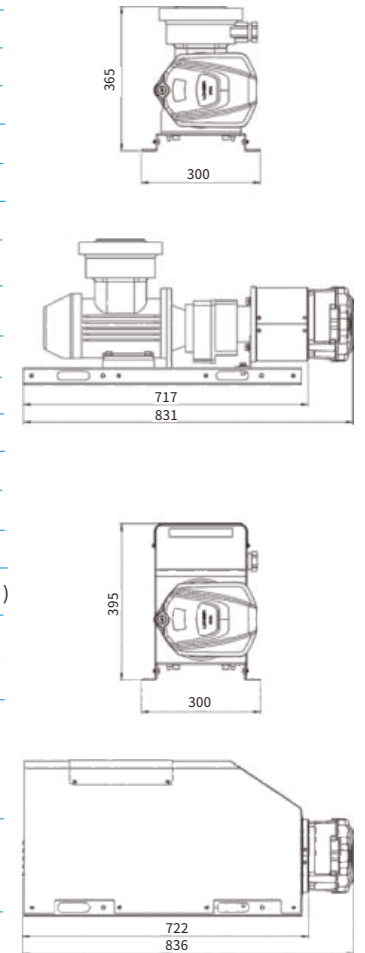

Pump Model (Product Code)	Pump Head	Roller Number	Tubing	Reference Max Flow Rate (L/min)
dPOFLEX EP01 (05.02.82A)	GPH01-1	2	26#, 73#, 82#, 184#	15
	GPH02-1	2	186#, 188#	17
	GPH03-1	4	186#, 188#	14

Laboratorial Syringe Pump dLSP 500 Series

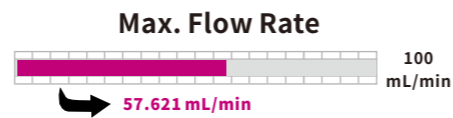

- Dedicated PC software and Android App permit remote control and monitoring
- Intelligent diagnosis and voice reminder for working progress and pump status
- High precision and stable fluid delivery with good EMC performance, ideal for microfluidic and electrospinning application
- 7 inch full touch screen with intuitive graphic interface for fantastic interactive experience
- Custom parameters can be configured quickly, and be stored and easily recalled
- User access control and log record for safety management. With the electronic signature function for FDA (21CFR Part 11) compliance



	dLSP 510	dLSP 520	dLSP 540*	dLSP 5A0*	dLSP 510 Pro	dLSP 520 Pro
Work mode	Infusion only, withdrawal only, infusion/withdrawal, withdrawal/infusion, auto repeated, programming (on dedicated PC software)					
Number of channel	1	2	4	10	1	2
Pusher advance per microstep	0.03255µm/µstep			0.015625µm/µstep		
Linear speed	0.0833µm/min-180mm/min			0.04µm/min-86.4mm/min		
Step speed	23.4375 sec/µstep-10.85 µsec/µstep					
Linear travel accuracy (Rated)	±0.5%			±0.35%		
Linear travel CV(Rated)	±0.05%					
Linear force (Rated)	Rated thrust 40lbs/18kg adjustable thrust					
Motor and drive	1.8° step motor with 1/64 microstepping					
Syringe	0.5uL-60mL	0.5uL-30mL	0.5uL-20mL	0.5uL-10mL	0.5uL-60mL	0.5uL-30mL
User-defined syringe	Travel≤108mm, OD≤31.5mm	Travel≤108mm, OD≤26mm	Travel≤108mm, OD≤22mm	Travel≤108mm, OD≤18mm	Travel≤108mm, OD≤31.5mm	Travel≤108mm, OD≤26mm
Display	7 Inch, 1024x600, IPS HD LCD					
Language	Chinese or English, set as needed					
Control mode	Touch screen control, dedicated PC or Android App control, footswitch control, RS485 communication control					
Interface	RS485(optional), USB-B,USB-A,Wifi, bluetooth, Ethernet, footswitch 3 outputs- solid state relay signal, 2 inputs-switch signal or TTL signal, 4-20mA signal(optional)					
Wireless connectivity(optional)	Wifi, bluetooth					
Programming function	Parameter configured based on work flow: constant, ramp, loop, delay, repeat, I/O output trigger, I/O event input trigger, touch screen trigger					
Calibration	Improve flow rate/ dispensing volume precision and accuracy					
Parameter method	Parameter methods can be stored and easily recalled					
Real time clock	Date and time can be set					
Audible alarm	For keypad clicks, end of run, near end of run, power on, motor stall, etc.					
Voice reminder	For working progress, alarm, diagnosis					
Intelligent diagnosis	N/A			For presence of syringes, syringe leakage		
Screen lock	To prevent misoperation					
User access control	Three levels of user accesses(administrator, developer, operator), in line with safety management requirement(21CFR Part 11)					
Log record	Record the complete operation history of the pump, and can be exported directly					
Electronic signature and audit trail	Meet the requirement of 21CFR Part 11 (on dedicated PC software)					
Support 3Q(IQ/OQ/PQ)	Meet GMP requirement					
EMC	CE (TUV) certified					
Deminsion(L×W×H)	Drive unit: 260mm×185mm×180mm, Controller: 190mm×123mm×33mm					
Power supply	AC 100V-240V/30W 50/60Hz			AC 100V-240V/20W 50/60Hz		
Operating condition	Temperature: 5°C-40°C, Relative humidity<85%					
IP rating	IP31					
Controller weight	0.4kg					
Pump drive weight	3.5kg	3.7kg	4kg	3.5kg		

Product Model		dLSP 510/dLSP 520/dLSP 540/dLSP 5A0		dLSP 510 Pro/dLSP 520 Pro	
Syringe	Syringe ID (mm)	Reference flow rate (nL/min-mL/min)			
0.5ul	0.1	0.0007nL/min-0.0014mL/min		0.0003nL/min-0.0007mL/min	
5ul	0.35	0.008nL/min-0.017mL/min		0.004nL/min-0.008mL/min	
10ul	0.5	0.016nL/min-0.035mL/min		0.008nL/min-0.017mL/min	
25ul	0.8	0.042nL/min-0.090mL/min		0.020nL/min-0.043mL/min	
50ul	1.1	0.079nL/min-0.171mL/min		0.038nL/min-0.082mL/min	
100ul	1.6	0.167nL/min-0.362mL/min		0.080nL/min-0.174mL/min	
500ul	3.25	0.691nL/min-1.493mL/min		0.332nL/min-0.717mL/min	
1ml	4.72	1.458nL/min-3.150mL/min		0.700nL/min-1.512mL/min	
2ml	9	5.299nL/min-11.451mL/min		2.545nL/min-5.497mL/min	
5ml	13.1	11.227nL/min-24.261mL/min		5.391nL/min-11.645mL/min	
10ml	16.6	18.028nL/min-38.956mL/min		8.657nL/min-18.699mL/min	
20ml	19	23.618nL/min-51.035mL/min		11.341nL/min-24.497mL/min	
30ml	23	34.609nL/min-74.786mL/min		16.619nL/min-35.897mL/min	
60ml (510 series)	29.14	55.554nL/min-120.044mL/min		26.677nL/min-57.621mL/min	

*product is in the process of certification

Laboratorial Syringe Pump L0107 Series

Mainly used in laboratorial applications. Controller and drive unit are separated. The drive unit has syringe holder and clamp.



Specifications	Model	TJ-1A/L0107-1A	TS-1A/L0107-1A, TS-1A-B/L0107-1A	TJ-2A/L0107-2A	TS-2A/L0107-2A, TS-2A-B/L0107-2A
Work mode		Infusion		Infusion, withdrawal, infusion/withdrawal, withdrawal/infusion, continuous	
Drive unit		1	1 to 4	1	1 to 4
Stroke of drive unit		70mm			
Pusher advance per microstep		0.165µm			
Linear speed		7.94µm/min-79.4mm/min (Flow rate=Linear speed * Section area of the barrel)			
Linear speed resolution		7.94µm/min			
Linear travel accuracy		≤ ±0.5% when travel ≥ 30% of drive unit stroke			
Linear force(max.)		>20N			
Syringe selection		Built-in syringe branches, sizes and IDs for selection			
Syringe user-defined		Can store four user-defined syringe IDs			
Flow rate calibration		Improve flow rate accuracy			
Running parameters setting		Parameters, such as dispensing volume, can be set by each channel. Or all channels use the parameters of the specified channel			
Start setting		Each drive unit can be started separately, simultaneously or according to each delay time			
Display setting		Display volume, flow rate or linear speed			
Power-off memory		Select keeping previous status or resetting parameters when powered on			
Fast forward/backward		Infuse or withdraw liquid at full speed			
Status signal output		2 output signals (OC gate signal) to indicate start/stop and direction			
Control signal input		3 input signals (TTL signal) to control start/stop, fast forward and fast backward			
Communication interface		RS485			
Controller dimensions (L×W×H)		170×108×65 (mm)	235×178×74 (mm)	170×108×65 (mm)	235×178×74 (mm)
Controller weight		0.5kg	0.8kg	0.5kg	0.8kg
Drive unit dimensions (L×W×H)		180×46×78 (mm)			
Drive unit weight		0.6kg			
Power supply		AC 90V-260V/10W	AC 90V-260V/40W	AC 90V-260V/10W	AC 90V-260V/40W
Operating temperature		0 to 40°C			
Relative humidity		<80%			

Controller Model(Product code, Language) /Drive Unit Model(Product code)	Syringe (µL)	Syringe ID(mm)	Flow Rate(nL/min-µL/min)
TJ-1A(05.03.10A, Chinese and English)/L0107-1A(05.03.00A)	5	0.35	0.764nL/min-7.64µL/min
TJ-2A(05.03.11A, Chinese and English)/L0107-2A(05.03.01A)	10	0.50	1.559nL/min-15.59µL/min
	25	0.80	3.991nL/min-39.91µL/min
TS-1A(05.03.15A, Chinese)/L0107-1A(05.03.00A)	50	1.10	7.546nL/min-75.46µL/min
TS-1A-B(05.03.15B, English)/L0107-1A(05.03.00A)	100	1.60	15.96nL/min-159.6µL/min
TS-2A(05.03.16A, Chinese)/L0107-2A(05.03.01A)	250	2.30	32.99nL/min-329.9µL/min
TS-2A-B(05.03.16B, English)/L0107-2A(05.03.01A)	500	3.25	65.87nL/min-658.7µL/min
	1000	4.61	132.5nL/min-1325µL/min

Laboratorial Syringe Pump

TJ-3A/W0109-1B, TS-1B/W0109-1B

Mainly used in laboratorial applications. Controller and drive unit are separated.



Specifications	Model	TJ-3A/W0109-1B	TS-1B/W0109-1B, TS-1B-B/W0109-1B
Work mode		Infusion, withdrawal, infusion/withdrawal, withdrawal/infusion, continuous	
Drive unit		1	1 to 4
Stroke of drive unit		90mm	
Pusher advance per microstep		0.165μm	
Linear speed		7.94μm/min-79.4mm/min (Flow rate=Linear speed * Section area of the barrel)	
Linear speed resolution		7.94μm/min	
Linear travel accuracy		≤ ±0.5% when travel ≥ 30% of drive unit stroke	
Linear force(max.)		>90N	
Syringe selection		Built-in syringe branches, sizes and IDs for selection	
Syringe user-defined		Can store four user-defined syringe IDs	
Flow rate calibration		Improve flow rate accuracy	
Running parameters setting		Parameters, such as dispensing volume, can be set by each channel. Or all channels use the parameters of the specified channel	
Start setting		Each drive unit can be started separately, simultaneously or according to each delay time	
Display setting		Display volume, flow rate or linear speed	
Power-off memory		Select keeping previous status or resetting parameters when powered on	
Fast forward/backward		Infuse or withdraw liquid at full speed	
Status signal output		2 output signals (OC gate signal) to indicate start/stop and direction	
Control signal input		3 input signals (TTL signal) to control start/stop, fast forward and fast backward	
Communication interface		RS485	
Controller dimensions (L×W×H)		170×108×65 (mm)	235×178×74 (mm)
Controller weight		0.5kg	0.8kg
Drive unit dimensions (L×W×H)		245×100×95 (mm)	
Drive unit weight		1.3kg	
Power supply		AC 90V-260V/10W	AC 90V-260V/40W
Operating temperature		0 to 40°C	
Relative humidity		<80%	

Controller Model (Product code, Language)	Drive Unit Model (Product code)	Syringe (mL)	Syringe ID(mm)	Flow Rate (μL/min-mL/min)
TJ-3A (05.03.12A, Chinese and English) TS-1B (05.03.17A, Chinese) TS-1B-B (05.03.17B, English)	W0109-1B (05.03.02A)	1	4.72	0.139μL/min-1.39mL/min
		2	9.00	0.505μL/min-5.05mL/min
		5	13.10	1.07μL/min-10.7mL/min
		10	16.60	1.718μL/min-17.18mL/min
		20	19.00	2.251μL/min-22.51mL/min
		30	23.00	3.298μL/min-32.98mL/min
		60	29.14	5.295μL/min-52.95mL/min

Laboratorial Syringe Pump

TJP-3A/W0109-1B

Mainly used in laboratorial applications. Controller and drive unit are separated. With the programmable function, you can customize complex infusion/withdrawal process, such as stepped infusion, combination constant speed and ramped speed infusion, trigger dispense or periodic dispense.



Work mode	Infusion, withdrawal, infusion/withdrawal, with drawal/infusion, continuous, programmable
Drive unit	1
Stroke of drive unit	90mm
Pusher advance per microstep	0.165μm
linear speed	7.94μm/min-79.4mm/min (Flow rate=Linear speed * Section area of the barrel)
Linear speed resolution	7.94μm/min
Linear travel accuracy	≤ ±0.5% when travel ≥ 30% of drive unit stroke
Linear force(max.)	>90N
Syringe selection	Built-in syringe branches, sizes and IDs for selection
Syringe user-defined	Can store four user-defined syringe IDs
Flow rate calibration	Improve flow rate accuracy
Running parameters setting	Parameters, such as dispensing volume, can be set by each channel. Or all channels use the parameters of the specified channel
Display setting	Display volume, flow rate or linear speed
Power-off memory	Select keeping previous status or resetting parameters when powered on
Fast forward/backward	Infuse or withdraw liquid at full speed
Status signal output	2 output signals (OC gate signal) to indicate start/ stop and direction
Control signal input	Falling edge or TTL signal to control Start/stop
Communication interface	RS485
Controller dimensions (L×W×H)	170×108×65 (mm)
Controller weight	0.5kg
Drive unit dimensions (L×W×H)	245×100×95 (mm)
Drive unit weight	1.3kg
Power supply	AC 90V-260V/10W
Operating temperature	0 to 40°C
Relative humidity	<80%

TJP-3A/W0109-1B Programmable Functions

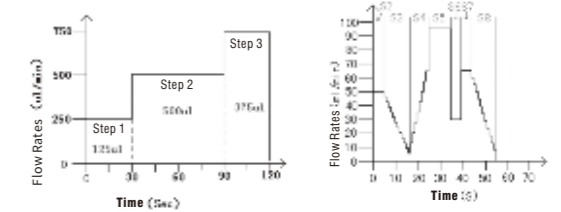

- Multi-step uniform speed (profile) infusion
- Complicated curve of Uniform Speed & Uneven Speed

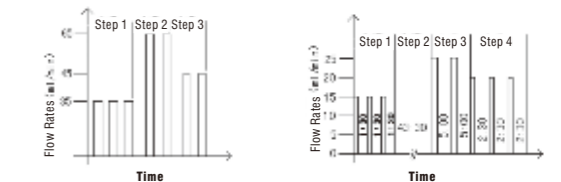

- Trigger Dispense
- Periodic Dispense



Controller Model (Product Code)	Drive Unit Model (Product Code)	Syringe (mL)	Syringe ID(mm)	Flow Rate (μL/min-mL/min)
TJP-3A(05.03.13A)	W0109-1B(05.03.02A)	1	4.72	0.139μL/min-1.39mL/min
		2	9.00	0.505μL/min-5.05mL/min
		5	13.10	1.07μL/min-10.7mL/min
		10	16.60	1.718μL/min-17.18mL/min
		20	19.00	2.251μL/min-22.51mL/min
		30	23.00	3.298μL/min-32.98mL/min
		60	29.14	5.295μL/min-52.95mL/min

Laboratorial Syringe Pump

TJ-4A/SL0104-1A, TJ-4A/SL0107-1A



TJ-4A/SL0104-1A

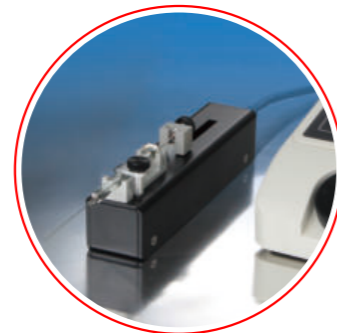

TJ-4A/SL0104-1A



Mainly used in veterinary medicine applications for intracellular injections or biological chemical dosing with small volume in picoliters. Drive unit has small size and lightweight, can be mounted on stereotaxic apparatus and micromanipulator.

Specifications	Model	TJ-4A/SL0104-1A	TJ-4A/SL0107-1A
Work mode		Infusion, withdrawal, infusion/withdrawal, withdrawal/infusion, continuous	
Drive unit		1	1
Stroke of drive unit		40mm	70mm
Pusher advance per step		3.048μm	
Linear speed		3.048μm/min-128.016mm/min(Flow rate=linear speed * section area of the barrel)	
Linear speed resolution		3.048μm/min	
Linear travel accuracy		≤±0.5%(when travel≥30% drive unit stroke)	
Linear force (max.)		>10N	
Syringe selection		Built-in syringe branches, sizes and IDs for selection	
Syringe user-defined		Can store four user-defined syringe IDs	
Flow rate calibration		Improve flow rate accuracy	
Running parameters setting		Parameters, such as dispensing volume, dispensing time, can be set through controller	
Display setting		Display volume, flow rate or linear speed	
Power-off memory		Select keeping previous status or resetting parameters when powered on	
Fast forward/ backward		Infuse or withdraw liquid at full speed	
Status signal output		2 output signals (OC gate signal) to indicate start/stop and direction	
Control signal input		3 input signals (TTL signal) to control start/stop, fast forward and fast backward	
Communication interface		RS485	
Controller dimensions (L×W×H)		170×108×65(mm)	
Controller weight		0.5kg	
Drive unit dimensions (L×W×H)		130×35×34(mm)	160×35×34(mm)
Drive unit weight		258g	289g
Power supply		AC 90V-260V/10W	
Operating temperature		0 to 40°C	
Relative humidity		<80%	

Controller Model(Product Code)	Drive Unit Model(Product Code)	Syringe(μL)	Syringe ID(mm)	Flow Rate(nL/min-μL/min)
TJ-4A (05.03.14A)	SL0104-1A (05.03.03A)	0.5	0.15	0.054nL/min-2.26μL/min
		1	0.20	0.096nL/min-4.02μL/min
		2	0.35	0.293nL/min-12.32μL/min
		5	0.50	0.598nL/min-25.1μL/min
		10	0.80	1.53nL/min-64.35μL/min
		25	1.10	2.90nL/min-121.66μL/min
		50	1.46	5.08nL/min-213.3μL/min
	SL0107-1A (05.03.04A)	0.5	0.10	0.024nL/min-1.0μL/min
		1	0.15	0.054nL/min-2.26μL/min
		2	0.20	0.096nL/min-4.02μL/min
		5	0.35	0.293nL/min-12.32μL/min
		10	0.50	0.598nL/min-25.1μL/min
		25	0.80	1.53nL/min-64.35μL/min
		50	1.10	2.90nL/min-121.66μL/min
		100	1.46	5.08nL/min-213.3μL/min

Laboratorial Syringe Pump

LSP Series

- Mainly used in biological laboratories and other places
- It is applicable to various specifications of syringes and can meet the needs of customers



LSP01-2A



LSP02-2A



LSP04-1A



LSP10-1B

Specifications	Model	LSP01-2A	LSP02-2A	LSP04-1A	LSP10-1B
Work mode		Infusion			Infusion, withdrawal, infusion/withdrawal, withdrawal/infusion, continuous
Channel		1	2	4	10
Stroke of pump		140mm			
Pusher advance per microstep		0.03125μm		0.156μm	
Linear speed		1μm/min-13mm/min		5μm/min-130mm/min(Flow rate=Linear speed * Section area of the barrel)	
Linear speed resolution		1μm/min		5μm/min	
Linear travel accuracy		≤±0.5% when travel ≥30% of pump stroke			
Linear force(max.)		>90N	>290N	>180N	
Syringe selection		Built-in syringe branches, sizes and IDs for selection			
Syringe user-defined		Can store four user-defined syringe IDs			
Flow rate calibration		Improve flow rate accuracy			
Running parameters setting		Infusion volume, infusion time, etc			Infusion/Withdrawal volume, infusion time, withdrawal time, pause time, etc
Display setting		Display volume, flow rate or linear speed			
Power-off memory		Storing the running parameters automatically			
Status signal output		2 output signals (OC gate signal) to indicate start/stop and direction			
Control signal input		Falling edge or TTL signal to control Start/stop			
Communication interface		RS485			
Dimensions (L×W×H)		280×210×140(mm)	280×250×140(mm)	280×330×140(mm)	
Weight		3.6kg	4.5kg	5.3kg	
Power supply		AC 90V-260V/15W		AC 90V-260V/20W	
Operating temperature		0 to 40°C			
Relative humidity		<80%			

Controller Model (Product Code)	LSP01-2A(05.03.41A) LSP02-2A(05.03.47A)	LSP04-1A(05.03.45A)	LSP10-1B(05.03.46A)
Syringe Syringe ID(mm)	Flow Rate(μL/min - mL/min)		
10uL 0.50	0.0002μL/min-0.0026mL/min	0.001μL/min-0.0255mL/min	0.001μL/min-0.0255mL/min
25uL 0.80	0.0005μL/min-0.0065mL/min	0.0025μL/min-0.0653mL/min	0.0025μL/min-0.0653mL/min
50uL 1.10	0.0095μL/min-0.0124mL/min	0.0048μL/min-0.1235mL/min	0.0048μL/min-0.1235mL/min
100uL 1.60	0.002μL/min-0.026mL/min	0.0101μL/min-0.2614mL/min	0.0101μL/min-0.2614mL/min
250uL 2.30	0.0042μL/min-0.054mL/min	0.0208μL/min-0.5401mL/min	0.0208μL/min-0.5401mL/min
500uL 3.25	0.0083μL/min-0.1078mL/min	0.0415μL/min-1.0784mL/min	0.0415μL/min-1.0784mL/min
1mL 4.72	0.0175μL/min-0.2275mL/min	0.0875μL/min-2.2747mL/min	0.0875μL/min-2.2747mL/min
2mL 9.00	0.0636μL/min-0.827mL/min	0.3181μL/min-8.2702mL/min	0.3181μL/min-8.2702mL/min
5mL 13.10	0.1348μL/min-1.7522mL/min	0.6739μL/min-17.522mL/min	0.6739μL/min-17.522mL/min
10mL 16.60	0.2164μL/min-2.8135mL/min	1.0821μL/min-28.135mL/min	1.0821μL/min-28.135mL/min
20mL 19.00	0.2835μL/min-3.6859mL/min	-	-
30mL 23.00	0.4155μL/min-5.4012mL/min	-	-
60mL 29.14	0.6669μL/min-8.6699mL/min	-	-

Laboratorial Syringe Pump

LSP01-3A, LSP02-2B



LSP01-3A



LSP02-2B



Mainly used in Lab applications.
Excellent EMC performance, ESD ≥ Level IV (IEC 61000-4-2)

Specifications	Model	LSP01-3A	LSP02-2B
Work mode		Infusion	Infusion, withdrawal, infusion/withdrawal, withdrawal/infusion, continuous
Channel		1	2
Stroke of pump		140mm	
Pusher advance per microstep		0.156μm	
Linear speed		5μm/min-65mm/min	5μm/min-130mm/min(Flow rate=Linear speed * Section area of the barrel)
Linear speed resolution		5μm/min	
Linear travel accuracy		≤ ±0.5% when travel ≥ 30% of pump stroke	
Linear force(max.)		>90N	>180N
Syringe selection		Built-in syringe branches, sizes and IDs for selection	
Syringe user-defined		Can store four user-defined syringe IDs	
Flow rate calibration		Improve flow rate accuracy	
Running parameters setting		Infusion volume, infusion time, etc	Infusion/Withdrawal volume, infusion time, withdrawal time, pause time, etc
Display setting		Display volume, flow rate or linear speed	
Power-off memory		Storing the running parameters automatically	
Status signal output		2 output signals (OC gate signal) to indicate start/stop and direction	
Control signal input		Falling edge or TTL signal to control Start/stop	
Communication interface		RS485	
Dimensions (L×W×H)		280×210×140 (mm)	280×250×140 (mm)
Weight		3.6kg	4.3kg
Power supply		AC 196V-240V/20W	AC 196V-240V/40W
Operating temperature		0 to 40°C	
Relative humidity		<80%	

Controller Model (Product Code)		LSP01-3A (05.03.40B)	LSP02-2B (05.03.44B)
Syringe	Syringe ID(mm)	Flow Rate(μL/min - mL/min)	
10μL	0.50	0.001μL/min-0.0128mL/min	0.001μL/min-0.0255mL/min
25μL	0.80	0.0025μL/min-0.0327mL/min	0.0025μL/min-0.0653mL/min
50μL	1.10	0.0048μL/min-0.0618mL/min	0.0048μL/min-0.1235mL/min
100μL	1.60	0.0101μL/min-0.1307mL/min	0.0101μL/min-0.2614mL/min
250μL	2.30	0.0208μL/min-0.2701mL/min	0.0208μL/min-0.5401mL/min
500μL	3.25	0.0415μL/min-0.5392mL/min	0.0415μL/min-1.0784mL/min
1mL	4.72	0.0875μL/min-1.1373mL/min	0.0875μL/min-2.2747mL/min
2mL	9.00	0.3181μL/min-4.1351mL/min	0.3181μL/min-8.2702mL/min
5mL	13.10	0.6739μL/min-8.7608mL/min	0.6739μL/min-17.522mL/min
10mL	16.60	1.0821μL/min-14.068mL/min	1.0821μL/min-28.135mL/min
20mL	19.00	1.4176μL/min-18.429mL/min	1.4176μL/min-36.859mL/min
30mL	23.00	2.0774μL/min-27.006mL/min	2.0774μL/min-54.012mL/min
60mL	29.14	3.3346μL/min-43.349mL/min	3.3346μL/min-86.699mL/min

Laboratorial Syringe Pump

LSP01-1C

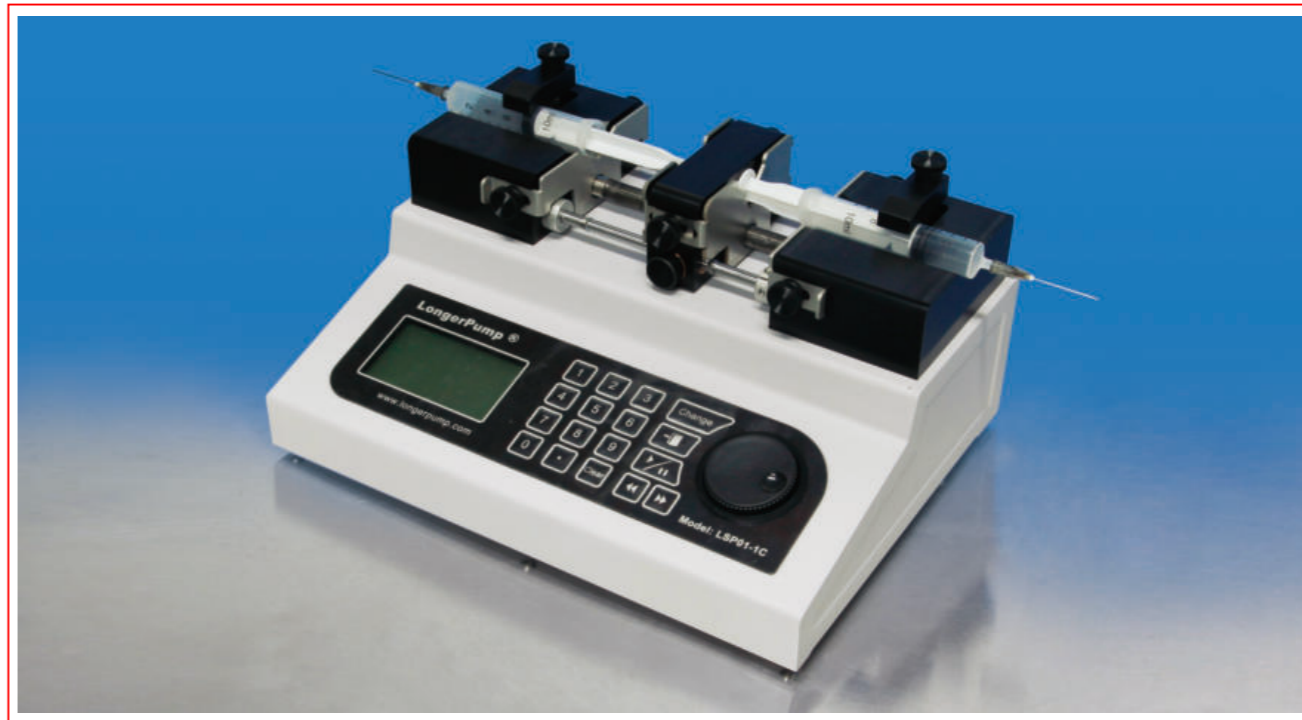

Mainly used in laboratorial applications.
High accuracy, suitable for continuous transferring of low-flow liquid.

LSP01-1C Tubing Connection Illustration

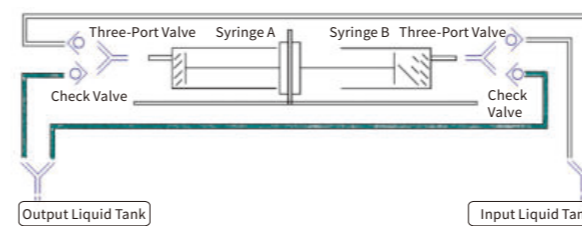

Work mode	Infusion and withdrawal synchronous and continuous
Channel	1
Stroke of pump	140mm
Pusher advance per microstep	0.156μm
Linear speed	5μm/min-65mm/min
Linear speed resolution	5μm/min
Linear travel accuracy	≤ ±0.5% when travel ≥ 30% of pump stroke
Linear force(max.)	>90N
Syringe selection	Built-in syringe branches, sizes and IDS for selection
Syringe user-defined	Can store four user-defined syringe IDS
Flow rate calibration	Improve flow rate accuracy
Running parameters setting	Dispensing volume, infusion time, etc.
Display setting	Display volume, flow rate or linear speed
Power-off memory	Storing the running parameters automatically
Status signal output	1 OC gate signal to indicate start/stop
Control signal input	Falling edge or TTL signal to control start/stop
Communication	RS485
Dimensions (L×W×H)	280×210×140(mm)
Weight	3.6kg
Power supply	AC 90V-260V/15W
Operating temperature	0 to 40°C
Relative humidity	<80%

Model	Product Code	Syringe	Syringe ID(mm)	Flow Rate(μL/min-mL/min)
LSP01-1C	05.03.42A	10uL	0.50	0.001μL/min-0.0128mL/min
		25uL	0.80	0.0025μL/min-0.0327mL/min
		50uL	1.10	0.0048μL/min-0.0618mL/min
		100uL	1.60	0.0101μL/min-0.1307mL/min
		250uL	2.30	0.0208μL/min-0.2701mL/min
		500uL	3.25	0.0415μL/min-0.5392mL/min
		1mL	4.72	0.0875μL/min-1.1373mL/min
		2mL	9.00	0.3181μL/min-4.1351mL/min
		5mL	13.10	0.6739μL/min-8.7608mL/min
		10mL	16.60	1.0821μL/min-14.068mL/min

Laboratorial High-pressure Syringe Pump

LSP01-1BH



Mainly used in laboratorial applications. Suitable for viscous and high pressure liquid transferring.

Work mode	Infusion, withdrawal, infusion/withdrawal, withdrawal/infusion, continuous
Channel	1
Stroke of pump	140mm
Pusher advance per microstep	0.156μm
Linear speed	5μm/min-130mm/min
Linear speed resolution	5μm/min
Linear travel accuracy	≤±0.5% when travel ≥30% of pump stroke
Linear force(max.)	>450N
Syringe selection	Built-in syringe branches, sizes and IDs for selection
Syringe user-defined	Can store four user-defined syringe IDs
Flow rate calibration	Improve flow rate accuracy
Running parameters setting	Infusion volume, infusion time, withdrawal time, pause time, etc
Display setting	Display volume, flow rate or linear speed
Power-off memory	Storing the running parameters automatically
Status signal output	2 output signals (OC gate signal) to indicate start/stop and direction
Control signal input	Falling edge or TTL signal to control Start/stop
Communication interface	RS485
Dimensions (L×W×H)	280×250×140 (mm)
Weight	6.3kg
Power supply	AC 90V-260V/25W
Operating temperature	0 to 40°C
Relative humidity	<80%



Model	Product Code	Syringe(mL)	Syringe ID(mm)	Flow Rate (μL/min-mL/min)	Outlet Pressure (Mpa)
LSP01-1BH	05.03.43A	2.5	4.79	0.0901μL/min-2.3426mL/min	19.48
		8	9	0.3181μL/min-8.2702mL/min	7.07
		20	19.05	1.4251μL/min-37.053mL/min	1.58
		50	28.6	3.2121μL/min-83.5152mL/min	0.56
		100	34.9	4.7831μL/min-124.361mL/min	0.37

Industrial Syringe Pump

SP1-CX, MSP1-CX



- Mainly used in OEM equipment and instruments, especially for lab automation systems and IVD application.
- Rotating valve, and misc. accessories available.
- RS485, RS232 or CAN bus communication interface.



	SP1-CX	MSP1-CX
Main Spec		
Accuracy	≤1.0% (syringe ≥1 mL)	
Precision	CV≤0.05% at full stroke (with syringe ≥ 500uL)	CV≤0.05% at full stroke (with syringe ≥1mL)
Wetted material	Borosilicate glass, PTFE, PFA, CTFE, ETFE, UHMW-PE, Ceramic	
Dimension(L×W×H)	114mm x 65mm x 254mm	110mm x 44.4mm x127mm
Weight	2.15 kg	1.0 kg
Power supply	DC 24V, 1.5A (peak)	
Syringe and Drive		
Syringe fitting	1/4"-28 thread	
Syringe	50uL, 100uL, 250uL, 500uL, 1mL, 2.5mL, 5mL, 10mL, 25mL	50uL, 100uL, 250uL, 500uL, 1mL, 2.5mL, 5mL
Syringe material	Borosilicate glass, stainless steel plunger with PTFE coating, PTFE or UHMW-PE plunger tip	
Resolution (standard mode)	6000 steps with 0.01mm in 1 step	3000 steps with 0.01mm in 1 step
Resolution (microstep mode)	48000 microsteps with 1.25um in 1 microstep	48000 microsteps with 0.625um in 1 microstep
Travel	60mm	30mm
Time for full stroke	1.26s-1200s	
Drive system	Ball screw drive with optical encoder	
Valve & Valve Drive		
Turn Time	≤250ms between adjacent ports	
Valve options	3-port Y valve, 3-port distribution valve, 6-port distribution valve, 9-port distribution valve, T valve, straight-through valve or distribution valve.	
Max pressure	0.68MPa	
Fitting	1/4"-28 thread	
Communication		
Interface	RS485, RS232, CAN bus, external control input and output	
Protocol	Data terminal, OEM protocol (serial) or CAN	
Baud rate	RS485 or RS232: 9600bps or 38400bps CAN bus: 100 KB, 125 KB 250 KB, 500 KB or 1MB	
Format	Data bit: 8; parity: none; stop bit: 1; half duplex (RS232/485)	
Firmware		
Topology group	Up to 15 pumps in one group, support group control and individually addressed	
Upgrade firmware online	"One Click" by customer through PC Utility	
Homing Algorithm	Plunger home position is identified by motor stall, which will reduce the dead volume of the system	
Halt function	For better interactive control, "h" command is used to halt execution of the command string during plunger movement. To resume execution with "R" or "r" command	
Microstep mode	Set microstep mode for smoother motion with 48000 microsteps per stroke, 1/8 microstepping or 1/16 microstepping	
Programmable parameter	Programmable ramps, cut-off velocity, plunger speeds, backlash compensation, programmable work-flow command set, delays and loops, terminate moves, diagnostics, absolute and relative positions	
Environmental		
Operating temperature	Recommended: 15°C-40°C, use low temperature syringe for low temperature application	
Operating Humidity	<80% RH, no condensation	
Storage temperature	-20°C-65°C	
Storage Humidity	<80% RH, no condensation	

Industrial Syringe Pump

MSP1-D1, MSP1-E1



Mainly used in OEM equipment and instruments, especially for automation systems.
Rotating valve, panel installation, RS485 or RS232 communication control.

Specifications	Model	MSP1-D1	MSP1-E1
Accuracy		≤1%(rated stroke)	
Precision		Repeatability≤0.5%(rated stroke)	
Rated stroke (steps)		30mm(1000 steps)	
Linear speed		0.5mm/s-15mm/s	
Time for rated stroke		2s-60s	
Control resolution		0.03mm(1 step)	
Transmission mechanism		Rack and pinion drive	
Plunger drive force (max.)		≥68N	
Secondary plunger drive force (max.)		≥34N	-
Syringe		500μL, 1mL, 2.5mL, 5mL	
Valve		3 port 120°	3-way solenoid valve
Valve plug turn time		≤280ms between adjacent ports	≤100ms
Wetted material		Borosilicate glass, PTFE, PCTFE	Borosilicate glass, PTFE, PEEK
Max. pressure		0.68Mpa	0.1Mpa
Tubing fitting		1/4"-28 thread	
Syringe fitting		1/4"-28 thread	
Signal input		1 input signals (TTL signal, drive current > 16mA)	
Signal output		1 output signals (OC gate signal) to indicate the working status	
Communication interface		RS485 or RS232	
Bit rate		9600bps or 38400bps	
Pump ID setting		Set the pump ID through BCD dial switch (0 to E corresponding to pump address 1-15)	
Pump parameters setting		Set the parameters through DIP switch	
Dimension (L×W×H)		100×65×127(mm)	
Power supply		DC 24V/1.5A	
Operating temperature		15 to 40°C	
Relative humidity		<80%	
Weight		0.9kg	

Industrial Multi-Channel Syringe Pump

SP4-D1, SP4-E1



Mainly used in OEM equipment and instruments, especially for automation systems.
Four channels synchronously running, high strength housing, panel or soleplate installation, RS485 or RS232 communication control.

Specifications	Model	SP4-D1	SP4-E1
Accuracy		≤1% (rated stroke)	
Precision		Repeatability≤0.5% (rated stroke)	
Rated stroke (steps)		60mm (1000 steps)	
Linear speed		0.03mm/s-24mm/s	
Time for rated stroke		2.5s-2000s	
Control resolution		0.06mm (1 step)	
Transmission mechanism		Synchronous belt mechanism	
Plunger drive force (max.)		≥68N for four channels	
Syringe		50μL, 100μL, 250μL, 500μL, 1mL, 2.5mL, 5mL	
Valve		No	3-way solenoid valve
Valve plug turn time		-	≤100ms
Wetted material		Borosilicate glass, PTFE, PPS	Borosilicate glass, PTFE, PEEK
Max. pressure		0.68 MPa (valve)	0.1MPa
Tubing fitting		1/4" -28 thread	
Syringe fitting		1/4" -28 thread	
Signal input		2 input signals (TTL signal, drive current >16mA) to restart the pump after pause	
Signal output		3 output signals (OC gate signal) to indicate the working status	
External Solenoid valve control		Can control 4 pcs of independent 24VDC solenoid valve. The rated drive signal for each valve is DC24V/200mA	With built-in solenoid valve
Communication interface		RS485 or RS232	
Bit rate		9600bps or 38400bps	
Pump ID setting		Set the pump ID through BCD dial switch	
Pump parameters setting		Set the parameters through DIP switch	
Dimension (L×W×H)		140×167×261.5 (mm)	
Power supply		DC 24V/1.5A	
Operating temperature		15 to 40°C	
Relative humidity		<80%	
Weight		2.4kg	

Micro Gear Pump

WT3000 Series



Mainly used in laboratorial applications.
Brushless motor, stainless steel pump head.



Pump Specification

Specifications	Model	WT3000-1FA	WT3000-1FB-A, WT3000-1FB-B	WT3000-1JA	WT3000-1JB-A, WT3000-1JB-B
Speed		300rpm-3000rpm			
Speed resolution		1rpm			
Dispensing volume		0.1mL-999L			
Copy number		0-9999, "0" means unlimited cycle	Not available		
Pause time		1s-999hr, resolution is 0.1s			
Calibration time		30s-1800s, resolution is 1s			
Diameter of particle in liquid		≤10μm			
Viscosity		≤200cSt			
Speed signal input		4-20mA, 0.5-5V, 1-10V, 1-10kHz corresponding to 300rpm-3000rpm			
Start/Stop signal input		TTL signal			
Speed output		1.25kHz-12.5kHz corresponding to 300rpm-3000rpm	Not available		
Start/Stop output		OC gate signal			
Communication interface		RS485			
Dimension (L×W×H)		232×142×149(mm)	290×207×180(mm)	232×142×149(mm)	290×207×180(mm)
Power supply		AC 90V-260V/50W	AC 220V±20%/150W or AC 110V±20%/150W	AC 90V-260V/50W	AC 220V±20%/150W or AC 110V±20%/150W
Operating condition		0 to 40°C			
Relative humidity		<80%			
IP rating		IP31			
Weight		2.83kg	5.1kg	2.83kg	5.1kg

Drive Model (Product code, Power supply)	Pump Head	Gear Material	Flow Rate (mL/min)	Outlet Pressure (Mpa)	Liquid Temperature (°C)	Weight (kg)
WT3000-1JA(05.06.01A)	MG204XD0PT00000	PEEK	85.7-857.1	≤0.8	-45-120	3.25
	MG204XD0TT00000	PTFE	85.7-857.1	≤0.8	-45-50	3.25
	MG209XD0PT00000	PEEK	171.4-1714.3	≤0.8	-45-120	3.26
WT3000-1FA(05.06.03A)	MG209XD0TT00000	PTFE	171.4-1714.3	≤0.8	-45-50	3.26
	MG213XD0PT00000	PEEK	257.1-2571.4	≤0.3	-45-120	3.28
	MG213XD0TT00000	PTFE	257.1-2571.4	≤0.3	-45-50	3.28
WT3000-1JB-A(05.06.02A, AC220V)	MS204XD0PT00000	PEEK	85.7-857.1	≤1.4	-45-120	5.39
WT3000-1JB-B(05.06.02B, AC110V)	MS209XD0PT00000	PEEK	171.4-1714.3	≤0.9	-45-120	5.4
WT3000-1FB-A(05.06.04A, AC220V)						
WT3000-1FB-B(05.06.04B, AC110V)						
	MS213XD0PT00000	PEEK	257.1-2571.4	≤0.8	-45-120	5.42

Micro Piston Pump

MP Series



High Precision, Long Life.
It can meet the strict requirement of In Vitro Diagnostic medical devices and analytical instruments for micro fluid transfer.

Pump Specification

Precision	Dispensing 100% of total volume	CV<0.1%(Pump Volume<500μL) CV<0.05%(Pump Volume ≥ 500μL)
	Dispensing 10% of total volume	CV<0.5%(Pump Volume<500μL) CV<0.1%(Pump Volume ≥ 500μL)
	Dispensing 1% of total volume	CV<2%(Pump Volume<500μL) CV<1%(Pump Volume ≥ 500μL)
Accuracy	≥99.5% at full dispensing	
Expected life	10 Million Cycles with Distilled Water 5 Million Cycles with Crystallizable solution	
System pressure	≤0.68Mpa(Depending on model)	
Full stroke	12.7mm	
Resolution	2000 steps: 0.00635mm/step	
	4000 steps: 0.003175mm/step	
Pump speed	Pump volume≤1mL: the min. time for full stroke is 0.8s	
	Pump volume of 2.5ml: the min. time for full stroke is 1s	
	Pump volume of 5ml: the min. time for full stroke is 1.2s	
Home positon detection	Optical switch is used to detect the home position of the piston to initiate accurate step counts	
Dimension(L×W×H)	61×45×132(mm)	
Relative humidity	20%-80%	
Temperature	5 to 40°C	
Weight	0.51kg	

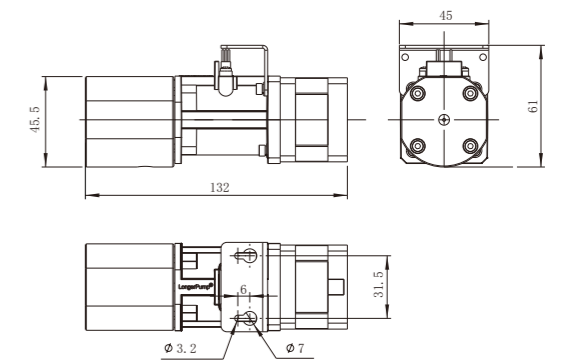

Pump Volume	Resolution(μL/step)	
	20TPI lead screw for 2000 steps	40TPI lead screw for 4000 steps
25μL	0.0125	0.00625
50μL	0.025	0.0125
100μL	0.05	0.025
250μL	0.125	0.0625
500μL	0.25	0.125
1000μL	0.5	0.25
2500μL	1.25	0.625
5000μL	2.5	1.25

Micro Piston Pump Model Configuration

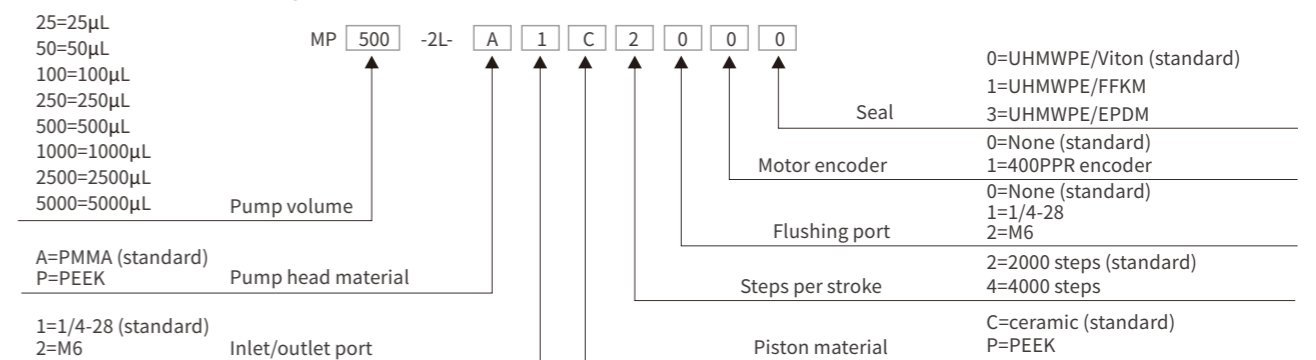

Medical Dialysis Pump

MTH18-12



Mainly used in hemodialysis applications. DC brushless motor, more stable, low noise. Small size, compact structure, ideal for OEM equipment and instruments. Brushless motor drive board (model:BLDCDRV-B1) is available. Or work with customer's specific drive board.

The lever of the rotor assembly helps to load the tubing easily and run the pump head manually.

The tubing and pump running condition can be easily monitored through the transparent PC cover. Cover open to stop to protect the operator and monitor pump status.

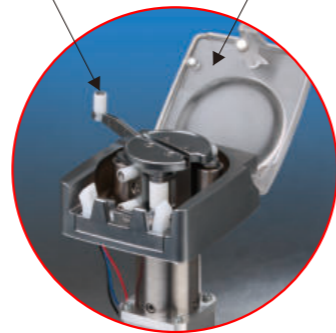

Installation Drawing

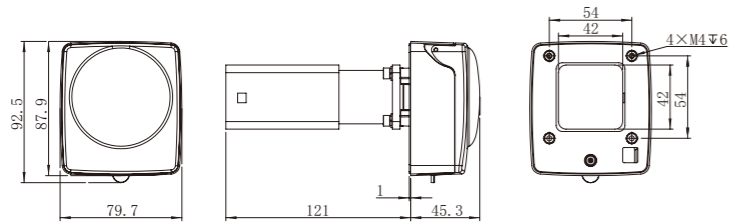

Motor Wiring

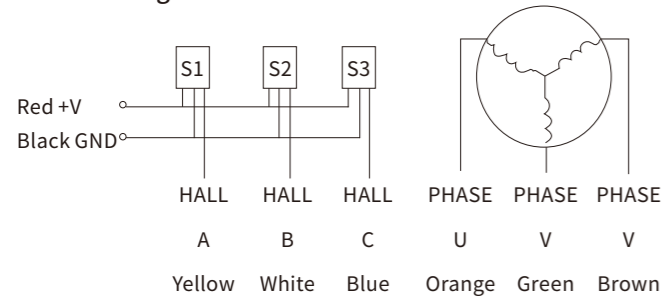

Model	Product Code	Roller Number	Roller Material	Housing and Cover Material	Speed (rpm)	Tubing ID×OD(mm)	Flow Rate (Only for reference)
MTH18-12	05.21.01A	2	304SS	Housing; Zinc Alloy /Chrome Coating Cover: PC	≤70rpm	6.5×10 4.6×8.4	5-300 2-165

Motor Specification

Voltage rating	24VDC
Current rating	3.2A
Pole-pairs number	8
Speed rating	4000rpm
Reduction ratio	1:19

Pump Specification

Speed	0-70rpm, CW/CCW
Tubing	OD≤10mm, Wall thickness 1.75±0.2mm
Flow rate	5-300mL/min(6.5mmID×10mmOD) 2-165mL/min(4.6mmID×8.4mmOD)
Dimension(L×W×H)	166×80×93mm
Relative humidity	<80%
Operating temperature	0 to 40°C
Weight	1.23kg

Peristaltic Pump Filling System

FU4B-1&FC32S-1, FU5B-1&FC32S-1



- Mainly designed for automatic filling & dispensing machine.
- 304ss housing has good corrosion resistance.
- Controller FC32S-1 and dispensing system FU4B-1/FU5B-1 are separated, to allow flexible mounting way.
- One dispensing unit of FU4B-1 has four channels, one dispensing unit of FU5B-1 has five channels. With modular structure, one controller can control 32 channels.
- Controller adopts 7 inch industrial touchscreen interface to operate easily and friendly.
- Each channel has independent membrane key and LED display, which can be used to set the channel address and calibrate the dispensing volume when system is running or stop.



Dispensing volume	0.1ml-9999.99ml (resolution: 0.01ml)
Dispensing time	0.5s-6000s (resolution: 0.1s)
Interval time	0.5s-999.9s
Dispensing cycle	0-999999, "0" means unlimited cycle
Delay time before back suction	0-60.0s
Back suction angle	0-1000°
Channel quantity	One FU4B-1 has 4 channels, one FU5B-1 has 5 channels. The system channels can be expended by modular structure. One controller can control 32 channels
Display	LCD
Control mode	Touchscreen control, external signal control or communication control
Start control signal input	Each dispensing unit has one pair of terminals for the external start signal
No bottle signal input	Each channel has individual terminals for the no bottle signal
Communication function	Rs485 communication interface, Modbus protocol, communication parameters (address, baud rate, parity, stop bit) can be set through touchscreen
Dispensing calibration	Dispensing volume of every channel can be calibrated through percentage, volume, weight or average weight method.
Channel enable	Every channel can be set as enable or disable
Fill/Backflow	All channels can be fast filling or backflowing at high speed simultaneously or separately
Channel address	Communication address of each channel can be set through independent membrane key and displayed on independent LED
Password function	Protect the system parameters and prevent misoperation through the password function
Dispensing parameter set	Dispensing parameters can be saved as a parameter set which can be invoked easily without reset it.
Dispensing unit dimension(L×W×H)	FU4B-1 (4 channels): 663mm × 218mm × 177mm FU5B-1 (5 channels): 823mm × 218mm × 177mm
Controller dimension(L×W×H)	228mm × 60mm × 146mm
Power supply	FU4B-1/FU5B-1: AC220V±20%/300W, FC32S-1: AC90V-260V/10W
Operating temperature	0 to 40°C
Relative humidity	<80%
IP rating	IP31
Weight	FU4B-1: 12kg, FU5B-1: 15kg, controller: 1.7kg



Model (Product Code)	Pump Head	Ref. Dispensing Volume (mL)	Tubing	Ref. Dispensing time (s)	Accuracy	Ref. Dispensing ID (mm)	Productivity (pcs/min)	
Dispensing System	YZ1515x YZ1115 FG15-13	0.3-0.5	13 [#]	1-1.2	≤±2%	≤0.5	27-30	
		1.0-2.3	14 [#]			≤1.0		
		2.6-5.1	19 [#]			≤1.5		
		4.6-9.1	16 [#]			≤2.0		
		10-19	25 [#]			≤3.0		
	FU4B-1 (05.11.02A) FU5B-1 (05.11.03A)	YZ1125	15-30			17 [#]		≤3.0
			8.0-17			15 [#]		≤3.0
			12-24			24 [#]		≤3.0
			8.5-17			15 [#]		≤3.0
			15-24			24 [#]		≤3.0
Controller	FG25-13	18-36	35 [#]	≤3.0				
		25-48	36 [#]	≤3.0				
		9-17	15 [#]	≤3.0				
	FC32S-1 (05.49.27A)	DMD15-13-B DMD15-13-D	12-24	24 [#]	≤3.0			
			0.1-0.9	2×13 [#]	≤0.5			
			0.2-2.3	2×14 [#]	≤1.0			
			0.5-5.9	2×19 [#]	≤2.0			
			2.0-10	2×16 [#]	≤3.0			
		5.0-25	2×25 [#]	≤3.0				

Peristaltic Pump Filling System

FK1-100Z

FK1-100Z is mainly designed for automatic filling & dispensing machines. Each unit has four channels and one controller. With modular structure, the channel number can be extended by mechanically connecting units.



Dispensing volume	0.5mL-100mL
Dispensing time	0.5 to 30s
Speed	1rpm-600 rpm
Back suction time	0 to 1s
Dispensing calibration	Calibrate dispensing volume to improve accuracy
Start/stop control signal input	1 switch signal
No bottle signal input	4 switch signals corresponding to 4 channels
Power-off memory	Storing the running parameter automatically
Communication interface	RS485
Dimension (L×W×H)	800×200×174 (mm)
Power supply	AC 220±10%/300W
Operating temperature	0 to 40°C
Relative humidity	<80%
IP rating	IP31
Weight	18.7kg

Model	Product Code	Pump Head	Dispensing Volume (mL)	Tubing	Dispensing Time (s)	Accuracy	Dispensing Head ID(mm)	Productivity (pcs/min)
FK1-100Z-B	05.11.00B	YZ1515x	2-3	14 [#]	1-1.5	≤±2%	≤1.5	30-24
			3-6	19 [#]	1-2		≤2.0	30-20
			6-12	16 [#]	1-2		≤3.0	30-20
			12-20	25 [#]	1-1.6		≤3.0	30-23
		YZ2515x	20-40	17 [#]	1-2		≤3.0	30-20
			12-20	15 [#]	1-1.6		≤3.0	30-23
			20-40	24 [#]	1-2		≤3.0	30-20
					1-2		≤3.0	30-20

dPOFLEX® High Precise Peristaltic Pump Filling System

PFU, PFS

- Precise filling of micro-volume as low as 30uL, accuracy better than ±1%
- Can be used independently as a small benchtop filling system, or integrated into semi-automatic systems or fully automated systems
- The master controller can control up to 32 channels, which can be set with individual parameters
- Three levels of user accesses, operation log, batch report with electronic signature, for FDA 21CFR Part 11



	PFU (Single Channel)	PFS (Four Channels)
Pump head	PFH01(microliter pump head) , PFH02 (milliliter pump head)	
Tubing	Silicone tubing and tubing kits	
Filling volume	1uL- 99.99L	
Filling accuracy	better than ±1%	
Filling precision	CV< 0.5%	
Filling time	0.1seconds-999.9hours	
Filling cycle	0-999999 (0 means unlimited)	
Interval time	0.1s - 999.9s	
Back suction parameter	0-30	
Working direction	Clockwise	
Calibration	Manual input calibration, balance reading calibration or online ratio calibration, with volume or mass data	
Display	7 inch touch screen, Chinese or English can be set	
Work mode	Single channel filling, multi-channel filling with the same parameters or individual parameters	
Access management and password protection	Three levels of user accesses (administrator, developer, operator), each user can have an exclusive password	
Parameter recipe	Up to 500 recipes can be stored and recalled easily on the PFC controller	
Batch report	Up to 800 batch reports can be stored on the PFC controller, which can be saved to USB flash drive or printed directly	
Communication control	Rs485 interface, Modbus RTU protocol	Rs485 interface, Modbus RTU protocol; or Ethernet interface, TCP/IP protocol as optional
External control input	Start the pump, emergency stop, disable channel	
Output	1 output for malfunction status	
IP rating	IP31	IP32
Power supply	AC 100V-240V , 50/60Hz , 60W	AC 100V-240V , 50/60Hz , 250W
Dimension (L*W*H)	119mm×203mm×176mm (without pump head)	548mm×245mm×198mm (without pump head)
Weight of system	3.5kg (without pump head)	16.1kg (without pump head)
Dimension of controller (L*W*H)	187mm×123mm×39mm	
Weight of controller	0.6kg	
Working condition	Temperature: 5 - 40°C , RH: ≤85%, no condensation	
Storage and transportation condition	Temperature: -40 - 70°C, RH: ≤85%, no condensation	

Syringe Pump Filling System

HMD04-1

Mainly used in filling & dispensing machine. With high accuracy, suitable for small volume dispensing.

Each unit has four channels. With modular structure, one controller can control up to four units.

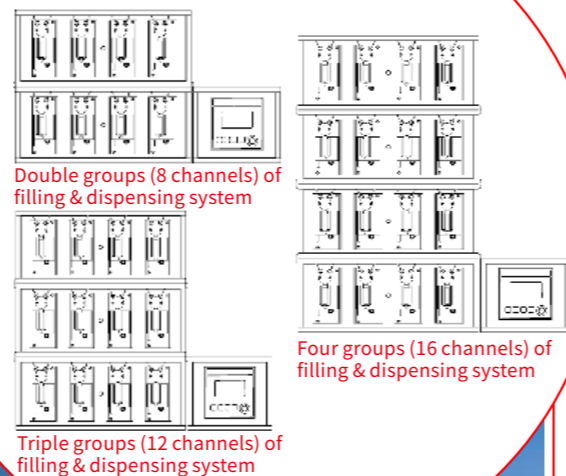

Accuracy	≤1% (dispensing volume is the 100% of syringe capacity)
Precision	Repeatability ≤0.5% (dispensing volume is the 100% of syringe capacity) Repeatability ≤2% (dispensing volume is more than 20% of syringe capacity)
Dispensing volume	100μL-5mL (dispensing volume is the 20%-100% of syringe capacity)
Speed	8.3μL/s to 2.5mL/s
Dispensing & filling time	Automatically calculate the time based on volume and speed
Pause time of dispensing	0 to 3600s
Copy number	1 to 30000, "0" means unlimited cycle
Calibration	Each channel dispensing volume is calibrated separately
Number of pretreatment, back flow, rinse	1 to 100
Syringe	500μL, 1mL, 2.5mL, 5mL, full stroke is 30mm
Wetted material	Borosilicate glass, PTFE, PCTFE
Max. pressure	0.68Mpa
Tubing fitting	1/4"-28 thread
Syringe fitting	1/4"-28 thread
Control mode	Control panel or external control
Dispensing start signal input	TTL signal, high level to trigger (all channels are controlled synchronously)
Rinse signal input	TTL signal, high level to trigger (all channels are controlled synchronously)
No bottle signal input	TTL signal, low level to trigger (each channel is controlled separately)
Dimensions (L×W×H)	600mm×256mm×170mm (Controller and drive unit)
Power supply	AC 90V-260V/60W
Operating temperature	15 to 40°C
Relative humidity	<80%
IP rating	IP31, Stainless steel housing
Weight	10kg (Controller + one unit)

OEM Peristaltic Pump Head

KZ10-24, KZ15-14

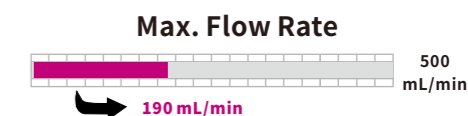

Compact structure, suitable for OEM peristaltic pump.

Two to four heads can be stacked for multi-channel applications.

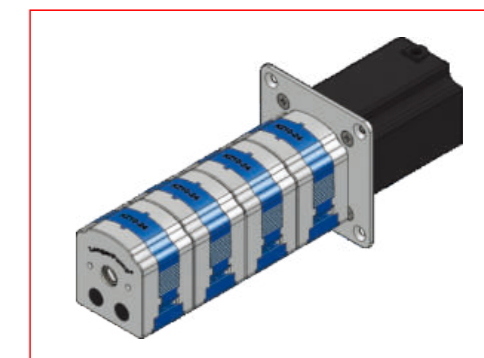

Installation Drawing

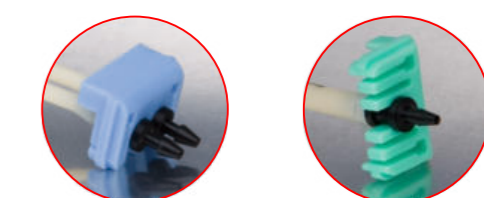
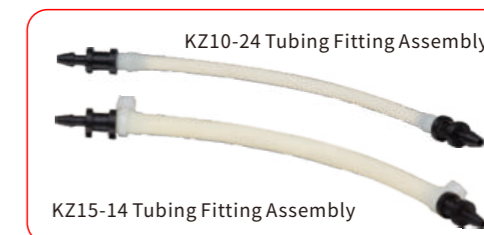
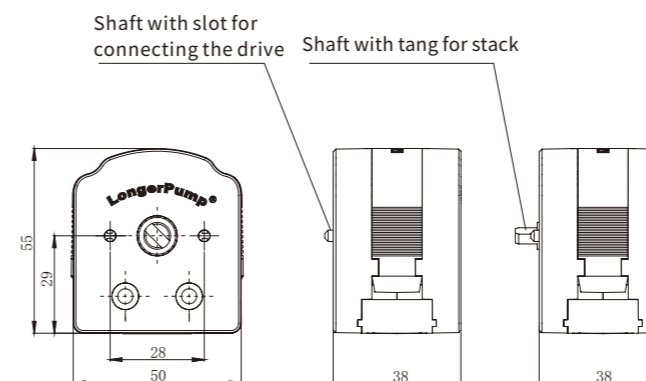

KZ10-24 tubing clammer KZ15-14 tubing clammer

Model	Shaft	Product Code	Channel Number	Roller Number	Roller Material	Housing Material	Speed (rpm)	Tubing	Max. Flow Rate (mL/min)	Weight (kg)
KZ10-24-A	Slot	05.01.27A	2	4	POM	POM	≤450	ID≤2.79(mm) Wall thickness 0.86(mm)	104	0.1
KZ10-24-B	Tang	05.01.27B			PVDF	PVDF				
KZ10-24-C	Slot	05.01.27C			POM	POM				
KZ10-24-D	Tang	05.01.27D			PVDF	PVDF				
KZ15-14-A	Slot	05.01.28A	1	4	POM	POM	≤450	13" 14" 19" 16"	190	0.1
KZ15-14-B	Tang	05.01.28B			PVDF	PVDF				
KZ15-14-C	Slot	05.01.28C			POM	POM				
KZ15-14-D	Tang	05.01.28D			PVDF	PVDF				

OEM Peristaltic Pump Without Drive

T-S403

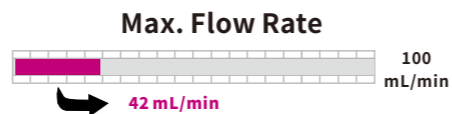

Step Motor.
Special pump head mounting bracket can be fitted with single KZ15-14 or KZ10-24 pump head.
Ideal OEM peristaltic pump for equipments and instruments.
Panel installation as standard.
Soleplate installation can be customized.
Meet RoHS requirement.

Installation Drawing

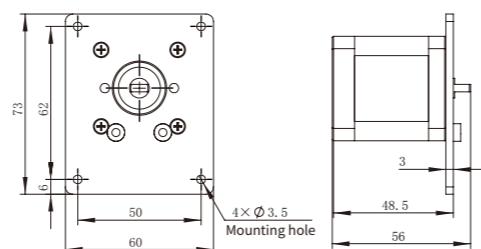

Motor Specifications

Step angle	1.8°
Phase	2
Phase voltage	6.56V
Phase current	0.8A
Resistance	8.2Ω±10%
Inductance	15.4mH±20%

Motor Port

Line Color	Definition
Brown	A
Orange	A̅
Red	B
Yellow	B̅

Pump Specification

Speed	≤100rpm
Dimension(L×W×H)	56×60×73(mm)
Relative humidity	<80%
Operating temperature	0 to 40°C

Model (Product Code)	Pump Head (Product Code)	Channel Number	Roller Number	Roller/Housing Material	Speed (rpm)	Tubing	Max. Flow Rate (mL/min)
T-S403 (05.65.203)	KZ10-24-A (05.01.27A)	2	4	POM	≤100rpm	ID≤3.17mm Wall thickness 0.86mm	23
	KZ10-24-C (05.01.27C)			PVDF			
	KZ15-14-A (05.01.28A)	1		POM		13" 14" 19" 16"	42
	KZ15-14-C (05.01.28C)			PVDF			

User Driven OEM Peristaltic Pump

T-S500&WX10-14-H

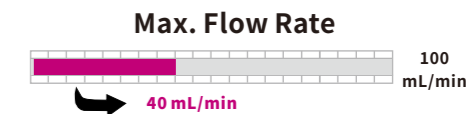

Pump Specification

Speed	≤100rpm
Max. Flow Rate	40mL/min
Tubing	ID≤3.17mm, wall thickness 0.8mm-1.0mm
Dimension (L×W×H)	106×61×81 (mm)
Relative humidity	<80%
Operating temperature	0 to 40°C

- Use WX10-14-H pump head and step motor.
- Ideal OEM peristaltic pump for equipment and instruments.
- Soleplate installation is standard, panel installation is optional.
- Meet RoHS requirement.

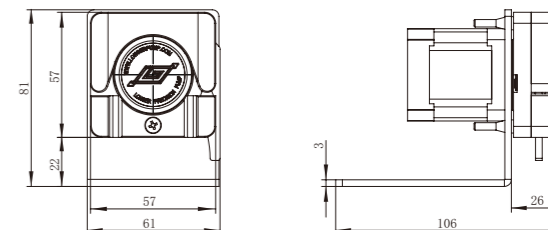

Motor Specifications

Step angle	1.8°
Phase	2
Phase voltage	6.56V
Phase current	0.8A
Resistance	8.2Ω±10%
Inductance	13.9mH±20%

Motor Port

Line Color	Definition
Brown	A
Orange	A̅
Red	B
Yellow	B̅

OEM Peristaltic Pump Without Drive

T-S502&JY10-14-H

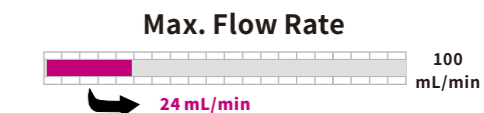

Pump Specification

Speed	≤60rpm
Max. flow rate	24mL/min
Tubing	ID≤3.17mm Wall thickness 0.8-1.0(mm)
Dimension(L×W×H)	66×82×100(mm)
Relative humidity	<80%
Operating temperature	0 to 40°C

- Use JY10-14 pump head and step motor.
- Ideal OEM peristaltic pump for equipment and instruments.
- Panel installation is standard, Soleplate installation is optional.
- Meet RoHS requirement.

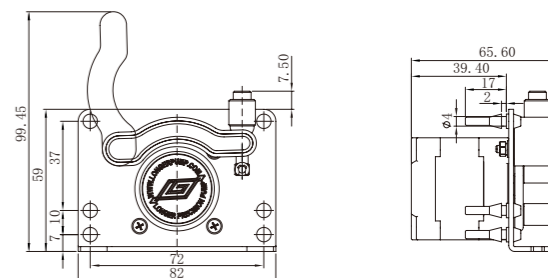

Motor Specifications

Step angle	1.8°
Phase	2
Phase voltage	8.4V
Phase current	0.6A
Resistance	14Ω±10%
Inductance	23.5mH±20%

Motor Port

Line Color	Definition
Red	A
Green	A̅
Yellow	B
Blue	B̅

User Driven OEM Peristaltic Pump

T-S501&JY15-12-C



Product Code:05.65.72C

Use JY15-12-C pump head and step motor.
Ideal OEM peristaltic pump for equipment and instruments.
Soleplate installation is standard, panel installation is optional.
Meet RoHS requirement.

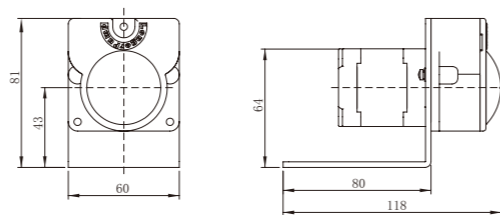
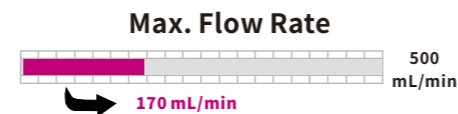

Pump Specification

Speed	≤100rpm
Dimension(L×W×H)	118×60×81(mm)
Relative humidity	<80%
Operating temperature	0 to 40°C

Tubing	Max. Flow Rate(mL/min)
25"	118mL/min
17"	170mL/min

Motor Specifications

Step angle	1.8°	Line Color	Definition
Phase	2	Brown	A
Phase voltage	6.56V	Orange	A̅
Phase current	0.8A	Red	B
Resistance	8.2Ω±10%	Yellow	B̅
Inductance	13.9mH±20%		

T-S400 OEM Peristaltic Pump Without Drive

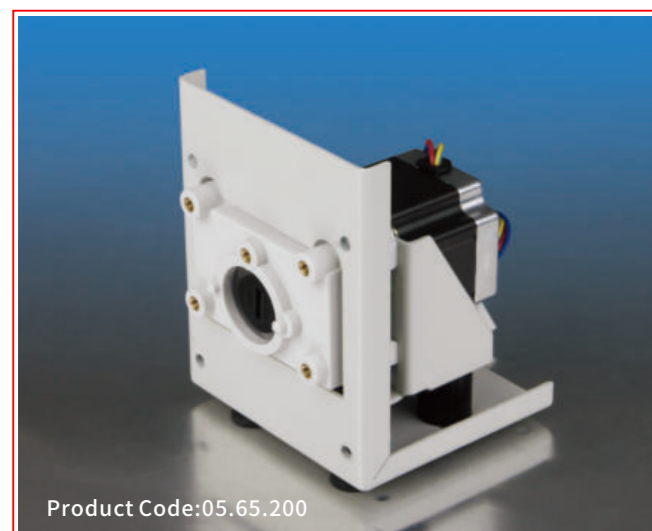

Product Code:05.65.200

Use step motor. Standard pump head mounting bracket can be fitted with several different pump heads.
Ideal OEM peristaltic pump for equipment and instruments.
Soleplate or panel installation.
Meet RoHS requirement.

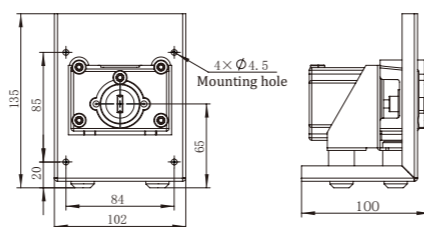
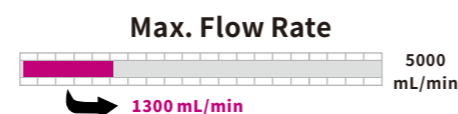

Pump Specification

Speed with DG pump head	≤100rpm
Speed with other pump head	≤300rpm
Dimension(L×W×H)	100×102×135(mm)
Relative Humidity	<80%
Operating Temperature	0 to 40°C

Motor Specifications

Step angle	1.8°	Line Color	Definition
Phase	2	Red	A
Phase voltage	2.7V	Green	A̅
Phase current	1.5A	Yellow	B
Resistance	1.8Ω±10%	Blue	B̅
Inductance	4.5mH±20%		

Pump Head	Tubing	Max. Flow Rate (mL/min)
YZ1515x, YZ1115	13" 14" 19" 16"	1140
	25" 17" 18"	
YZ2515x, YZ1125	15" 24"	840
DG-1(6), DG-2(6)	ID ≤3.17(mm)	48(Single Channel)
DG-1(10), DG-2(10)	Wall Thickness 0.8-1(mm)	32(Single Channel)
BZ15-13-A	14"	75
BZ15-13-B	16"	230
BZ15-13-C	25"	480
BZ15-13-D	17"	840
BZ25	24"	800
FG15-13-B	13" 14" 19" 16" 25" 17" 18"	1300
FG25-13-B	15" 24"	900
DMD15-13-B	2×13" 2×14"	
DMD15-13-D	2×19" 2×16" 2×25"	1050

User Variable Speed OEM Peristaltic Pump

T100&WX10-14 Series



Use WX10-14 pump head.
Mainly designed for OEM applications.
Multi-control modes are available.
Soleplate installation is standard, panel installation is optional.

Installation Drawing

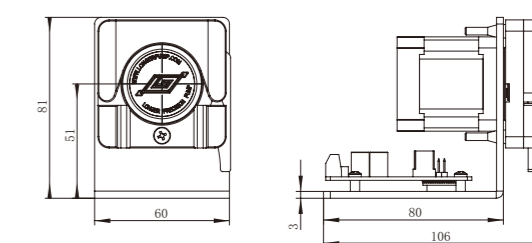

Pump Specification

Items	Specification
Speed	≤100rpm
Speed resolution	0.1rpm
Max. flow rate	40mL/min
Tubing	ID≤3.17mm wall thickness 0.8mm-1.0mm
*Direction control	Direction is controlled by external switch signal.CW when switch is open, CCW when switch is closed
*Start/stop control	Start/stop is controlled by external switch signal. Pump runs when switch is open, stops when switch is closed
*BCD dial switch speed control	The speed is divided into 15 grades. BCD position 1-F corresponding to (rpm)5,10,15,20,25,30,35,40,45,50,60, 70,80,90,100 (rpm)
*External speed control (optional)	4-20mA corresponding to 0.1-100rpm, 0-5V corresponding to 0-100rpm, 0-10V corresponding to 0-100rpm, 0-10kHz corresponding to 0-100rpm
**Communication pump ID	Pump ID range is 1-30
**Bit rate	1200bps or 9600bps
Dimension(L×W×H)	106 x 60 x 81 (mm)
Relative humidity	<80%
Operating temperature	0 to 40°C
Power supply	DC11.4V-25.2V
Power consumption	≤12W
Weight	0.51kg

Note: Items with * are only available for products with dial switch and external speed control signal.
Items with ** are only available for product with RS485.



Pump Selection Table

Model	Product Code	Control Mode	Certificate
T100-S300&WX10-14-H	056001H	Dial switch and external signal (4-20mA)	CE certified and Meet RoHS requirement
T100-S301&WX10-14-H	056002H	Dial switch and external signal (0-5V)	
T100-S302&WX10-14-H	056003H	Dial switch and external signal (0-10V)	
T100-S303&WX10-14-H	056004H	Dial switch and external signal (0-10kHz)	
T100-S500&WX10-14-H	056005H	RS485 communication	

User Variable Speed OEM Peristaltic Pump

T100&JY15-12 Series

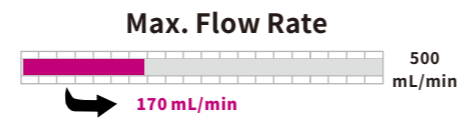
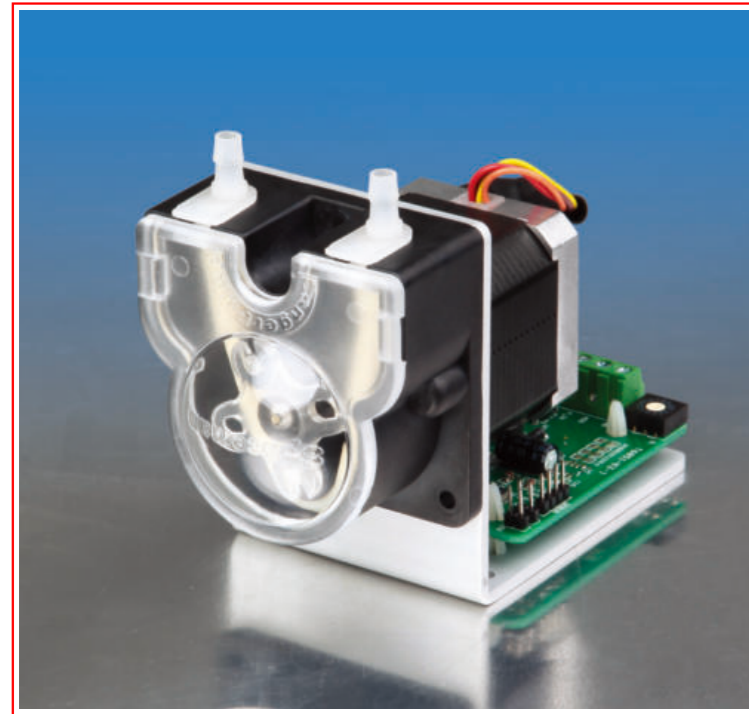

Use JY15-12 pump head,
Mainly designed for OEM applications.
Multi-control modes are available.
Soleplate installation is standard,
panel installation is optional.

Installation Drawing

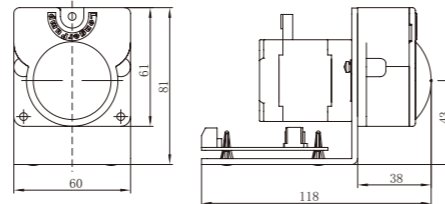

Tubing	Max. Flow Rate(mL/min)
25"	118mL/min
17"	170mL/min

Pump Specification

Items	Specification
Speed	≤100rpm
Speed resolution	0.1rpm
*Direction control	Direction is controlled by external switch signal. CW when switch is open, CCW when switch is closed
*Start/stop control	Start/stop is controlled by external switch signal. Pump runs when switch is open, stops when switch is closed
*BCD dial switch speed control	The speed is divided into 15 grades. BCD position 1-F corresponding to (rpm)5,10,15,20,25,30,35,40,45,50, 60,70,80,90,100 (rpm)
*External speed control (optional)	4-20mA corresponding to 0.1-100rpm, 0-5V corresponding to 0-100rpm, 0-10V corresponding to 0-100rpm, 0-10kHz corresponding to 0-100rpm
**Communication pump ID	Pump ID range is 1-30
**Bit rate	1200bps or 9600bps
Dimension (L×W×H)	118×60×81(mm)
Relative humidity	<80%
Operating temperature	0 to 40°C
Power supply	DC11.4V-25.2V
Power consumption	≤12W
Weight	0.54kg

Note: Items with * are only available for products with dial switch and external speed control signal.
Items with ** are only available for product with RS485.

Pump Selection Table

Model	Product Code	Control Mode	Certificate
T100-S300&JY15-12-C	056030C	Dial switch and external signal (4-20mA)	CE certified and Meet RoHS requirement
T100-S301&JY15-12-C	056031C	Dial switch and external signal (0-5V)	
T100-S302&JY15-12-C	056032C	Dial switch and external signal (0-10V)	
T100-S303&JY15-12-C	056033C	Dial switch and external signal (0-10kHz)	
T100-S500&JY15-12-C	056034C	RS485 communication	

User Variable Speed OEM Peristaltic Pump

T100-S320

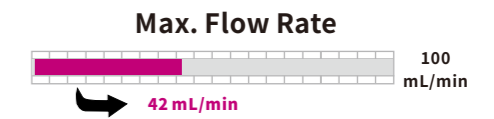

Multi-control Modes.
Special pump head mounting bracket
can be fitted with single KZ15-14 or
KZ10-24 pump head.
Ideal OEM peristaltic pump for
equipment and instruments.
Soleplate or panel installation.

Installation Drawing

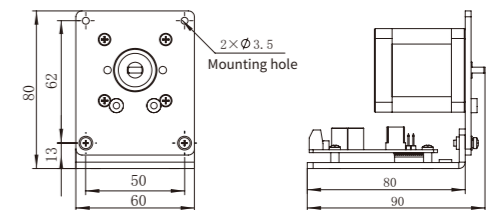

Pump Specification

Items	Specification
Speed	≤100rpm
Speed resolution	0.1rpm
*Direction control	Direction is controlled by external switch signal. CW when switch is open, CCW when switch is closed
*Start/stop control	Start/stop is controlled by external switch signal. Pump runs when switch is open, stops when switch is closed
*BCD dial switch speed control	The speed is divided into 15 grades. BCD position 1-F corresponding to 5, 10, 15, 20, 25, 30, 35, 40, 45, 50, 60, 70, 80, 90, 100 (rpm)
*External speed control (optional)	4-20mA corresponding to 0.1-100rpm, 0-5V corresponding to 0-100rpm, 0-10V corresponding to 0-100rpm, 0-10kHz corresponding to 0-100rpm
**Communication pump ID	Pump ID range is 1-30.
**Bit rate	1200bps or 9600 bps
Dimension(L×W×H)	90×60×80(mm)
Relative humidity	<80%
Operating temperature	0 to 40°C
Power supply	DC11.4V-25.2V/12W

Note: Items with * are only available for products with dial switch and external speed control signal.

Pump Selection Table

Model	Product Code	Control Mode	Certificate
T100-S320	05.60.130	Dial switch and external signal (4-20mA)	Meet RoHS requirement
T100-S321	05.60.131	Dial switch and external signal (0-5V)	
T100-S322	05.60.132	Dial switch and external signal (0-10V)	
T100-S323	05.60.133	Dial switch and external signal (0-10kHz)	
T100-S502	05.60.202	RS485 communication	

Model (Product Code)	Pump Head (Product Code)	Channel Number	Roller Number	Roller/Housing Material	Speed (rpm)	Tubing	Max. Flow Rate (mL/min)
KZ10-24-A	05.01.27A	2	4	POM	≤100rpm	ID≤3.17mm Wall thickness 0.86mm	23
KZ10-24-C	05.01.27C			PVDF			
KZ15-14-A	05.01.28A	1		POM		13" 14" 19" 16"	42
KZ15-14-C	05.01.28C			PVDF			

User Variable Speed OEM Peristaltic Pump

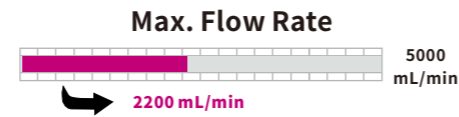

T100/T300/T600 Series

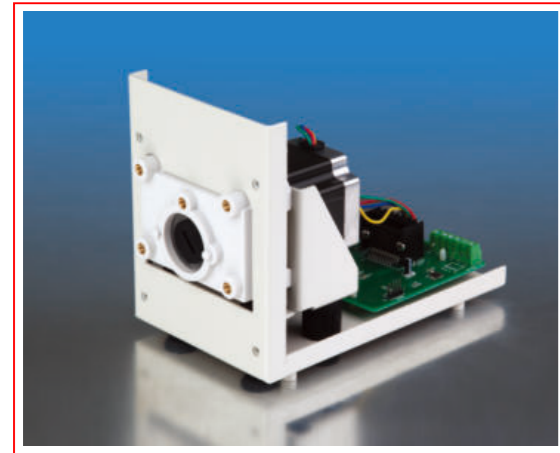

Good EMC performance.
Multi-control modes.
Standard pump head mounting bracket can be fitted with several different pump head.
Low vibration, low noise.
Soleplate or panel installation.

Installation Drawing

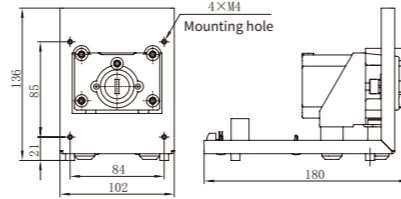

User Variable Speed OEM Peristaltic Pump

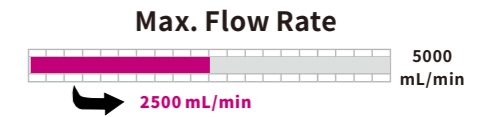

DC Brushless Motor Series

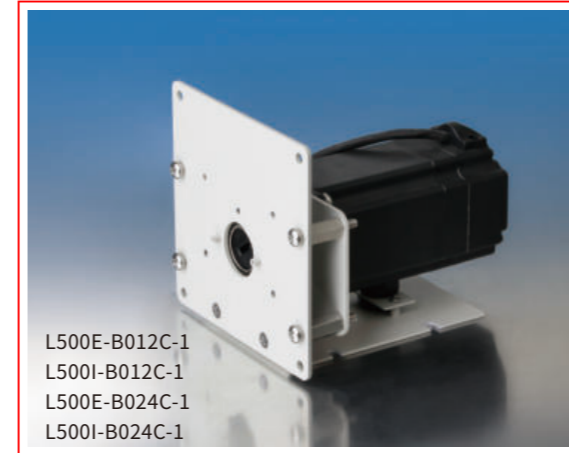

L500E-B012C-1
L500I-B012C-1
L500E-B024C-1
L500I-B024C-1

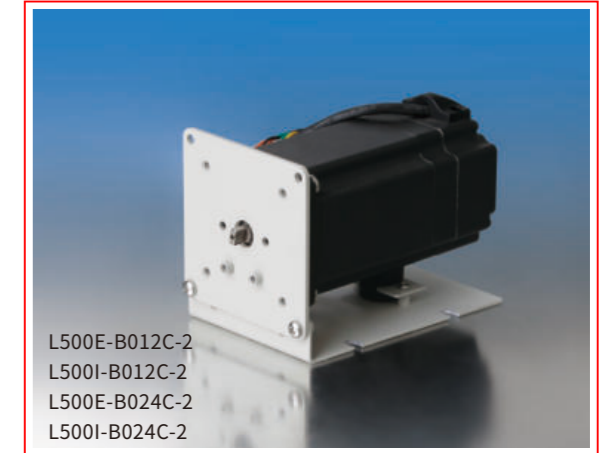

L500E-B012C-2
L500I-B012C-2
L500E-B024C-2
L500I-B024C-2

Pump Specification

Item	T100 Series	T300 Series	T600 Series
Speed	0-100rpm	0-300rpm	0-600rpm
Speed resolution	0.1rpm	1rpm	1rpm
*Direction control	Direction is controlled by external switch signal. CW when switch is open, CCW when switch is closed		
*Start/stop control	Start/stop is controlled by external switch signal. Pump runs when switch is open, stops when switch is closed		
*BCD dial switch speed control	The speed is divided into 15 grades. BCD position 1-F corresponding to 5, 10, 15, 20, 25, 30, 35, 40, 45, 50, 60, 70, 80, 90, 100(rpm)	The speed is divided into 15 grades. BCD position 1-F corresponding to 5, 10, 20, 40, 60, 80, 100, 125, 150, 175, 200, 225, 250, 275, 300(rpm)	The speed is divided into 30 grades: 5, 10, 20, 40, 60, 80, 100, 125, 150, 175, 200, 225, 250, 275, 300, 320, 340, 360, 380, 400, 420, 440, 460, 480, 500, 520, 540, 560, 580, 600 (rpm)
*External speed control signal (optional)	4-20mA, 0-5V, 0-10V, 0-10kHz		
**Communication control	RS485 interface, compatible both with Longer OEM protocol and Modbus protocol		
**Communication Pump ID	Pump ID range is 1-30		
**Bit rate	1200bps or 9600bps		
**Power-off memory	Return to previous status when powered on		
Dimension(Lx Wx H)	180 x 102 x 136 (mm)		
Relative humidity	<80%		
Operating temperature	0°C~40°C		
Power supply	DC24V/50W	DC24V/50W	DC24V/80W
Weight	1.43kg	1.63kg	

Note: Items with * are only available for products with dial switch and external speed control signal. Items with ** are only available for product with RS485 communication control.

Product Model

T100 Series Product Model	T300 Series Product Model	T600 Series Product Model	Control Mode
T100-SV-10	T300-SV-10	T600-SV-10	Dial switch and external signal (0-10V)
T100-SA	T300-SA	T600-SA	Dial switch and external signal (4-20mA)
T100-SF	T300-SF	T600-SF	Dial switch and external signal (0-10kHz)
T100-SC	T300-SC	T600-SC	RS485 communication
T100-SV-05	T300-SV-05	T600-SV-05	Dial switch and external signal (0-5V)

Pump Head	Tubing	Max. Flow Rate Reference(mL/min)		
		T100 Series	T300 Series	T600 Series
YZ1515x, YZ II 15	13" 14" 19" 16" 25" 17" 18"	380	1140	2200
YZ2515x, YZ II 25	15" 24"	270	840	1600
FG15-13	13" 14" 19" 16" 25" 17" 18"	430	1200	2400
FG25-13	15" 24"	320	1100	2200
DMD15-13-B, DMD15-13-D	2x13" 2x14" 2x19" 2x16" 2x25"	375	1040	2070
BZ15-13-A	14"	22	80	150
BZ15-13-B	16"	80	240	460
BZ15-13-C	25"	150	470	960
BZ15-13-D	17"	270	800	1600
BZ25-13-B	24"	250	800	1600
DG15-24	16" 25" 17"	300 (Single Channel)	900 (Single Channel)	1800 (Single Channel)
DG15-28	13", 14", ID≤3.17(mm), Wall thickness:1(mm)	75(Single Channel, speed≤100rpm)		
DG-1(6), DG-2(6)	ID≤3.17(mm), Wall thickness:0.8-1(mm)	48(Single Channel, speed≤100rpm)		
DG-1(10), DG-2(10)	ID≤3.17(mm), Wall thickness:0.8-1(mm)	32(Single Channel, speed≤100rpm)		

Brushless DC motor with built in controller has better reliability, longer life time and much lower noise.
Simple to control the speed by potentiometer or 0-4V analogue signal.
Fitted with different pump heads.
Soleplate or panel installation.

Pump Specification

Items	Specification

Installation Drawing

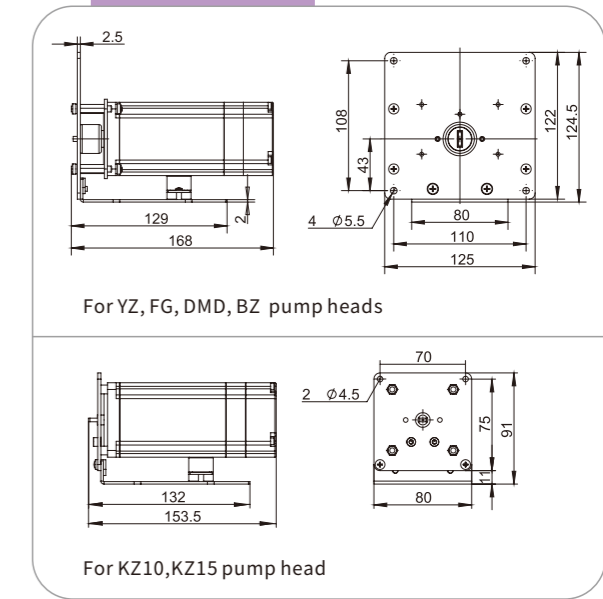

Model (Product code, Speed control, Power supply)	Pump head	Tubing	Max. Flow Rate (mL/min)	Weight (kg)
L500E-B012C-1 (05.71.100, 0-4V, 12VDC)	YZ1515x, YZII15	13" 14" 19" 16" 25" 17" 18"	1830	2.73
	YZ2515x	15" 24"	1330	
	YZII25	15" 24" 35" 36" (36" only can be used for the pump with 24VDC)	1830 (pump with 12VDC) 2500 (pump with 24VDC)	
L500I-B012C-1 (05.71.101, [knob], 12VDC)	FG15-13	13" 14" 19" 16" 25" 17" 18"	1790	2.61
	FG25-13	15" 24"	1600	
L500E-B024C-1 (05.71.102, 0-4V, 24VDC)	DMD15-13-B, DMD15-13-D	2x13" 2x14" 2x19" 2x16"	800	2.76
	BZ15-13-A	14"	125	
	BZ15-13-B	16"	380	
	BZ15-13-C	25"	800	
	BZ15-13-D	17"	1340	
L500I-B024C-1 (05.71.103, [knob], 24VDC)	BZ25-13-B	24"	2340	2.64
L500E-B012C-2 (05.71.104, 0-4V, 12VDC)	(1, 2, 3, 4) x KZ15-14 (Max.Speed: 450rpm)	13" 14" 19" 16"	190	2.13-2.43
L500I-B012C-2 (05.71.105, [knob], 12VDC)				
L500E-B024C-2 (05.71.106, 0-4V, 24VDC)	(1, 2, 3, 4) x KZ10-24 (Max.Speed: 450rpm)		104	
L500I-B024C-2 (05.71.107, [knob], 24VDC)				

Note: [knob]--Potentiometer with knob.

User Variable Speed OEM Peristaltic Pump

Max. Flow Rate

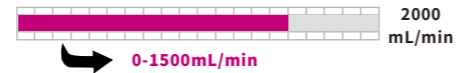

DC Brushless Motor Series

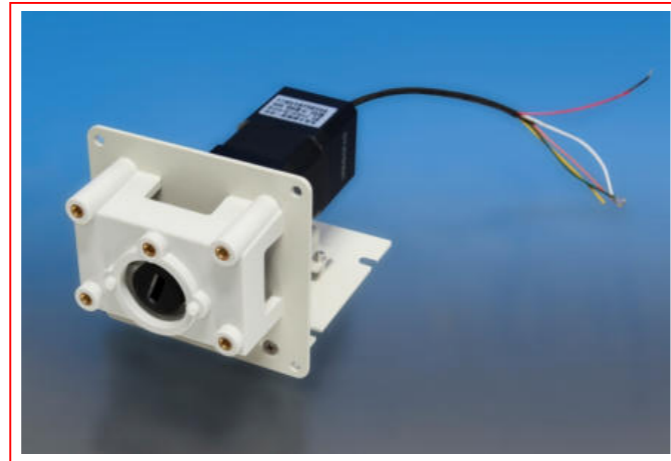
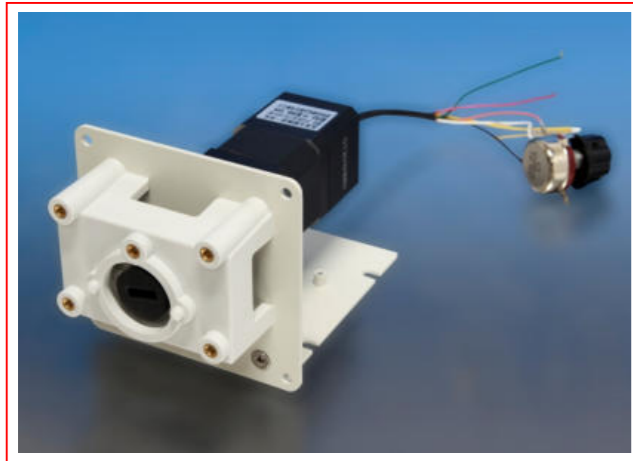

Installation Drawing

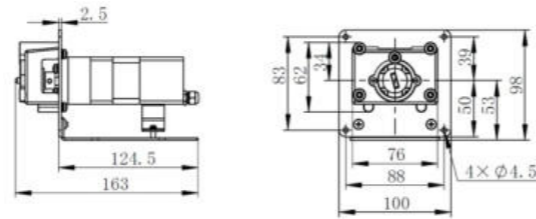

Brushless DC motor with built in controller has better reliability and longer life.
Fitted with different pump heads and support stacked pump heads for multichannel.
Mainly for OEM instrument and equipment.
Soleplate or panel installation.

Pump Specification

Product Model	T100-BV-24	T100-BM-24	T300-BV-24	T300-BM-24
Speed	0rpm-100rpm, CW/CCW		0rpm-300rpm, CW/CCW	
Speed resolution	1rpm			
Start/stop control	Start/stop is controlled by external switch signal. Pump runs when switch is closed, stops when switch is open			
Direction control	Direction is controlled by external switch signal. CCW when switch is closed, CW when switch is open			
Speed control	0-5V analogue signal control	Potentiometer control	0-5V analogue signal control	Potentiometer control
Dimension(L×W×H)	163x100x98(mm)			
Operating temperature	0°C~40°C			
Relative humidity	≤80°C			
Power supply	24VDC/50W		24VDC/80W	
Weight	1.01kg			

Applicable Pump Head	Tubing	Max Flow Rate Reference(ml/min)		Weight with pump head (kg)
		T100-BV-24, T100-BM-24	T300-BV-24, T300-BM-24	
(1,2,3)×YZ1515x	13" 14" 19" 16" 25" 17" 18"	380(single channel)	1140(single channel)	1.41-2.21
(1,2,3)×YZ1115	13" 14" 19" 16" 25" 17" 18"	380(single channel)	1140(single channel)	1.36-2.06
(1,2,3)×YZ2515x	15" 24"	270(single channel)	840(single channel)	1.41-2.21
YZ1125	15" 24" 35" 36"	500(single channel)	1500(single channel)	1.41
FG15-13-B	13" 14" 19" 16" 25" 17" 18"	430	1290	1.29
FG25-13-B	15" 24"	320	960	1.29
DMD15-13-B/DMD15-13-D	2×13" 2×14" 2×19" 2×16" 2×25"	375	1125	1.44
BZ15-13-A	14"	22	66	1.32
BZ15-13-B	16"	80	240	1.32
BZ15-13-C	25"	150	450	1.32
BZ15-13-D	17"	270	810	1.32
BZ25-13-B	24"	250	750	1.32
DG-(1,2,4,6,8)6 rollers	ID≤3.17mm Wall thickness0.8-1mm	48 (single channel)	Not applicable	1.21-1.64
DG-(1,2,4,6,8)10 rollers	ID≤3.17mm Wall thickness0.8-1mm	32 (single channel)	Not applicable	1.22-1.68

Fixed Speed OEM Peristaltic Pump

Max. Flow Rate

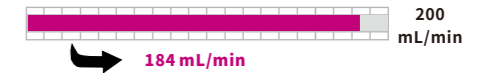

TH15 Series



AC Synchronous Motor Outline Drawing

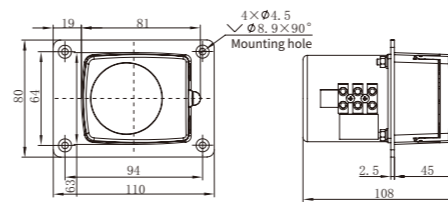

DC/AC Motor Outline Drawing

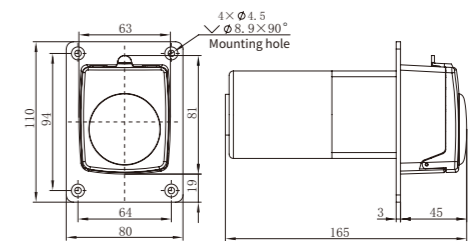

Model	Installation Mode	Product Code	Speed (rpm)	Motor	Power Supply	Speed Tolerance	Motor Life	Operating Temperature	Relative Humidity
G14-D2&TH15	Panel	05.52.01A	14	60 DC gear motor	DC 12V/15W	≤ ±10%	2000 hours	0 to 40°C	<80%
G28-D2&TH15		05.52.02A	28						
G56-D2&TH15		05.52.03A	56						
G93-D2&TH15		05.52.04A	93						
G15-D102&TH15		05.54.01A	15						
G30-D102&TH15		05.54.02A	30						
G57-D102&TH15		05.54.03A	57	60 AC gear motor	DC 24V/15W				
G98-D102&TH15		05.54.04A	98						
G15-A2&TH15		05.56.21A	15						
G30-A2&TH15		05.56.22A	30						
G60-A2&TH15		05.56.23A	60						
G100-A2&TH15		05.56.24A	100						
G5-A102&TH15		05.56.01A	5	60 AC synchronous motor	AC 220V/10W				
G15-A102&TH15		05.56.02A	15						
G30-A102&TH15		05.56.03A	30						
G50-A102&TH15	05.56.04A	50							
G60-A102&TH15	05.56.05A	60							
G110-A102&TH15	05.56.11A	110							

Motor	DC Gear Motor								AC Gear Motor				AC synchronous Gear Motor					
	DC 12V				DC 24V				AC 220V				AC 220V					
Power Supply	14	28	56	93	15	30	57	98	15	30	60	100	5	15	30	50	60	110
Speed(rpm)	14	28	56	93	15	30	57	98	15	30	60	100	5	15	30	50	60	110
Tubing	Flow Rate(ml/min)																	
13"	1	2	4	7	1	2	4	7	1	2	4	7	0	1	2	4	4	8
14"	3	6	12	20	3	7	13	22	3	7	14	22	1	3	7	11	13	24
19"	7	14	28	47	8	15	30	49	8	15	31	50	3	8	15	25	30	55
16"	11	22	45	74	12	24	47	78	12	24	50	80	4	12	24	40	48	88
25"	23	47	94	155	25	50	99	164	25	50	104	167	8	25	50	84	100	184

Fixed Speed OEM Peristaltic Pump

60 Series

Max. Flow Rate



Installation Drawing

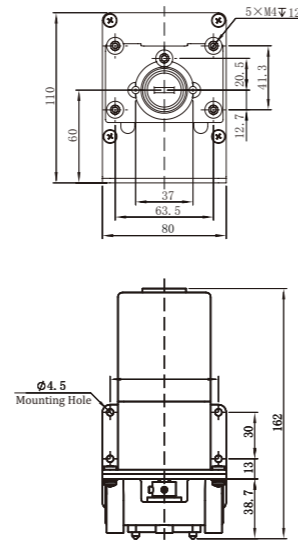

Pump Head Options



Model	Installation Mode	Product Code	Speed (rpm)	Motor	Power Supply	Speed Tolerance	Motor Life	Operating Temperature	Relative Humidity
G14-D1	Soleplate Panel	05.51.011	14	60 DC gear motor	DC 12V/24W	≤ ±10%	2000 hours	0 to 40°C	<80%
G14-D2	Panel	05.51.012	14						
G28-D1	Soleplate Panel	05.51.031	28						
G28-D2	Panel	05.51.032	28						
G56-D1	Soleplate Panel	05.51.041	56						
G56-D2	Panel	05.51.042	56						
G93-D1	Soleplate Panel	05.51.051	93						
G93-D2	Panel	05.51.052	93						
G186-D1	Soleplate Panel	05.51.311	186						
G186-D2	Panel	05.51.312	186						
G15-D101	Soleplate Panel	05.53.011	15						
G15-D102	Panel	05.53.012	15						
G30-D101	Soleplate Panel	05.53.021	30						
G30-D102	Panel	05.53.022	30						
G59-D101	Soleplate Panel	05.53.031	59						
G59-D102	Panel	05.53.032	59						
G99-D101	Soleplate Panel	05.53.041	99						
G99-D102	Panel	05.53.042	99						
G196-D101	Soleplate Panel	05.53.311	196	60 AC gear motor	AC 220V/33W		5000 hours		
G196-D102	Panel	05.53.312	196						
G15-A1	Soleplate Panel	05.55.011	15						
G15-A2	Panel	05.55.012	15						
G30-A1	Soleplate Panel	05.55.021	30						
G30-A2	Panel	05.55.022	30						
G60-A1	Soleplate Panel	05.55.071	60						
G60-A2	Panel	05.55.072	60						
G88-A1	Soleplate Panel	05.55.041	88						
G88-A2	Panel	05.55.042	88						
G147-A1	Soleplate Panel	05.55.311	147						
G147-A2	Panel	05.55.312	147						

Parameters Table

Pump Head		DG-(1, 2, 4, 6) 6 Rollers			DG-(1, 2, 4, 6) 10 Rollers					
Tubing		1×1	2×1	3×1	1×1	2×1	3×1			
Speed(rpm)	Power Supply	Flow Rate(mL/min)								
14	DC 12V	1	4	7	1	3	4			
28		2	8	13	2	6	9			
56		4	16	27	3	12	18			
93		7	26	45	6	20	30			
15	DC 24V	1	4	7	1	3	5			
30		2	8	14	2	7	10			
59		5	17	28	4	13	19			
99		8	28	48	6	22	32			
15	AC 220V	1	4	7	1	3	5			
30		2	8	14	2	7	10			
62		5	17	30	4	14	20			
88		7	25	42	5	19	28			
Pump Head		YZ1515x, YZ1115								
Tubing		13"	14"	19"	16"	25"	17"	18#		
Speed(rpm)	Power Supply	Flow Rate(mL/min)								
14	DC 12V	1	4	6	11	22	37	51		
28		2	7	12	21	45	75	103		
56		4	14	23	43	90	149	205		
93		6	23	39	71	149	248	341		
186	DC 24V	12	47	78	143	298	—	—		
15		1	4	6	12	24	40	55		
30		2	8	13	23	48	80	110		
59		4	15	25	45	94	157	216		
99	AC 220V	6	25	41	76	158	264	363		
196		12	49	82	150	314	—	—		
15		1	4	6	12	24	40	55		
30		2	8	13	23	48	80	110		
62	AC 220V	4	16	26	48	99	165	227		
88		6	22	37	67	141	235	323		
147		9	37	61	113	235	—	—		
Pump Head		YZ2515x, YZ1125		BZ25	BZ15-13-A	BZ15-13-B	BZ15-13-C	BZ15-13-D		
Tubing		15#	24"	24#	14#	16#	25#	17"		
Speed(rpm)	Power Supply	Flow Rate(mL/min)								
14	DC 12V	22	37	37	4	11	22	37		
28		45	75	75	7	21	45	75		
56		90	149	149	14	43	90	149		
93		149	248	248	23	71	149	248		
186	DC 24V	—	—	—	47	143	298	—		
15		24	40	40	4	12	24	40		
30		48	80	80	8	23	48	80		
59		94	157	157	15	45	94	157		
99	AC 220V	158	264	264	25	76	158	264		
196		—	—	—	49	150	314	—		
15		24	40	40	4	12	24	40		
30		48	80	80	8	23	48	80		
62	AC 220V	99	165	165	16	48	99	165		
88		141	235	235	22	67	141	235		
147		—	—	—	37	113	235	—		
Pump Head		FG15-13-B						FG25-13-B		
Tubing		13"	14"	19"	16"	25"	17"	18"	15#	24"
Speed(rpm)	Power Supply	Flow Rate(mL/min)								
14	DC 12V	1	4	9	15	31	46	50	26	41
28		2	8	19	31	62	92	100	53	82
56		4	15	37	62	125	185	200	106	165
93		6	26	62	105	207	308	333	176	275
186	DC 24V	12	51	124	210	415	616	666	364	574
15		1	4	10	17	33	49	53	28	44
30		2	8	20	34	67	99	107	57	88
59		4	16	39	66	131	195	211	112	174
99	AC 220V	6	27	66	112	221	328	354	188	293
196		12	54	130	222	437	650	702	384	605
15		1	4	10	17	33	49	53	28	44
30		2	8	20	34	67	99	107	57	88
62	AC 220V	4	17	41	70	138	205	222	117	183
88		6	24	59	99	196	291	315	167	260
147		9	54	98	166	328	487	—	—	—

Fixed Speed OEM Peristaltic Pump

80 Series

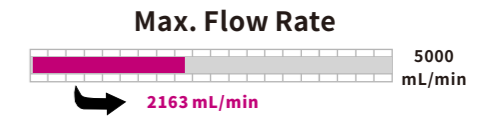

Installation Drawing

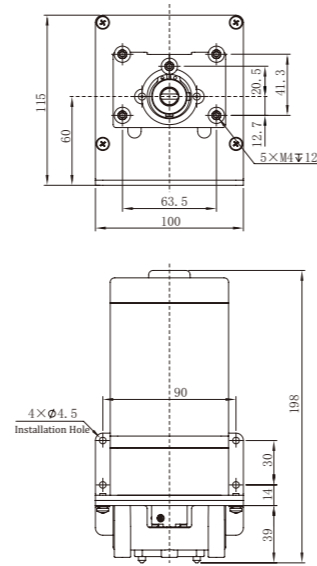

Pump Head Options

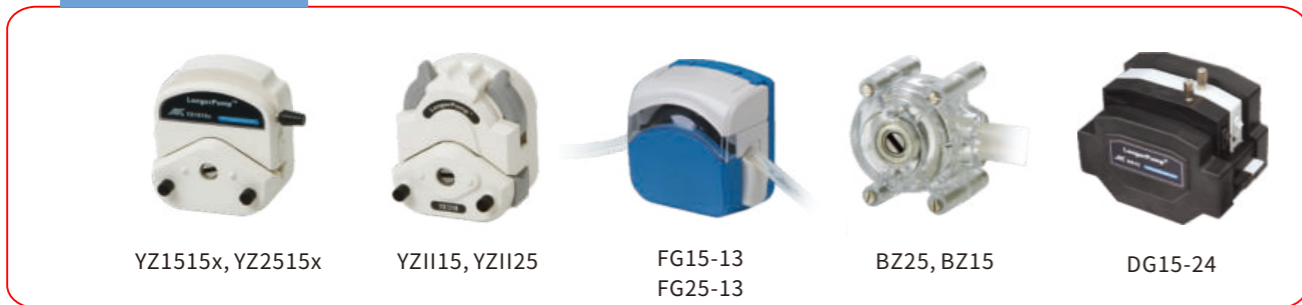

Model	Installation Mode	Product Code	Speed (rpm)	Motor	Power Supply	Speed Tolerance	Motor Life	Operating Temperature	Relative Humidity
G186-D3	Soleplate Panel	05.51.313	186	80 DC gear motor	DC 12V/40W	≤ ±10%	2000 hours	0 to 40°C	< 80%
G186-D4	Panel	05.51.314	186						
G311-D3	Soleplate Panel	05.51.511	311						
G311-D4	Panel	05.51.512	311						
G560-D3	Soleplate Panel	05.51.721	560						
G560-D4	Panel	05.51.722	560						
G196-D103	Soleplate Panel	05.53.313	196						
G196-D104	Panel	05.53.314	196						
G327-D103	Soleplate Panel	05.53.511	327						
G327-D104	Panel	05.53.512	327						
G590-D103	Soleplate Panel	05.53.711	590	80 AC gear motor	AC 220V/40W		5000 hours		
G590-D104	Panel	05.53.712	590						
G147-A3	Soleplate Panel	05.55.313	147						
G147-A4	Panel	05.55.314	147						
G220-A3	Soleplate Panel	05.55.411	220						
G220-A4	Panel	05.55.412	220						
G366-A3	Soleplate Panel	05.55.511	366						
G366-A4	Panel	05.55.512	366						

Parameters Table

Pump Head		DG15-24								
Tubing		16"	25"	17"						
Speed (rpm)	Power Supply	Flow Rate (mL/min)								
186	DC 12V	152	357	558						
311		254	596	933						
560		457	1073	1680						
196	DC 24V	160	376	588						
327		267	627	981						
590		482	1131	1770						
147	AC 220V	120	282	441						
220		180	422	660						
366		299	702	1098						
Pump Head		YZ1515x, YZ1115								
Tubing		13"	14"	19"	16"	25"	17"	18"		
Speed (rpm)	Power Supply	Flow Rate (mL/min)								
186	DC 12V	12	47	78	143	298	496	682		
311		20	78	130	238	498	829	1140		
560		35	140	233	429	896	1493	2053		
196	DC 24V	12	49	82	150	314	523	719		
327		21	82	136	251	523	872	1199		
590		37	148	246	452	944	1573	2163		
147	AC 220V	9	37	61	113	235	392	539		
220		14	55	92	169	352	587	807		
366		23	92	153	281	586	976	1342		
Pump Head		YZ2515x, YZ1125		BZ25	BZ15-13-A	BZ15-13-B	BZ15-13-C	BZ15-13-D		
Tubing		15"	24"	24"	14"	16"	25"	17"		
Speed (rpm)	Power Supply	Flow Rate (mL/min)								
186	DC 12V	298	496	496	47	143	298	496		
311		498	829	829	78	238	498	829		
560		896	1493	1493	140	429	896	1493		
196	DC 24V	314	523	523	49	150	314	523		
327		523	872	872	82	251	523	872		
590		944	1573	1573	148	452	944	1573		
147	AC 220V	235	392	392	37	113	235	392		
220		352	587	587	55	169	352	587		
366		586	976	976	92	281	586	976		
Pump Head		FG15-13-B						FG25-13-B		
Tubing		13"	14"	19"	16"	25"	17"	18"	15"	24"
Speed (rpm)	Power Supply	Flow Rate (mL/min)								
186	DC 12V	12	51	9	210	415	616	666	364	574
311		20	86	207	352	694	1031	1114	663	1074
560		35	154	373	634	1250	1857	2006	1251	1820
196	DC 24V	12	54	130	222	437	650	702	384	605
327		21	90	218	370	730	1084	1171	697	1130
590		37	162	393	668	1317	1956	2114	1340	1907
147	AC 220V	9	40	98	166	328	487	526	288	454
220		14	61	146	249	491	729	788	458	688
366		23	101	244	414	817	1213	1311	781	1265

Peristaltic Pump Hose

Features of peristaltic pump tubing

- Good flexibility. Spring back after pressed radially
- Good wear abrasion resistance
- A certain extent pressure bearing capabilities
- Lower gas permeability
- Low absorption, good temperature resistance, not easy to aging, not swelling, anti-corrosion, fewer extractable.

Tubing parameters

Inner diameter and wall thickness are the main parameters of the tubing. Different manufacturers have different notations. Such as: specification codes or inner diameter × wall thickness.

Tubing materials

Silicon rubber, rubber, plastic, synthetic material, etc. Different materials have different characteristics and different applications.

Tubing selection factors

Chemical Compatibility

When transferring different fluids, the tubing should have good chemical characteristics. Such as: low absorption, good temperature resistance, good aging characteristics, low swelling, anti-corrosion, fewer extractable.

Chemical resistance decreases as temperature increases. Chemicals that have no effect on the tubing at room temperature could attack the tubing at elevated temperatures.

Chemical compatibility test method:

When the chemical compatibility of the tubing is uncertain, an immersion test is needed. In an immersion test, a small piece of tubing is weighed, and its diameter and length are measured. The tubing then is immersed in a closed vessel with the chemical in question for a minimum of 48 hours. Afterward, the test piece of tubing is rinsed, dried, weighed and measured, and any changes are recorded. The tubing also should be examined for signs of softening or embrittlements, which indicate the chemical has attacked the tubing. If the tubing survives the test without discoloration, swelling, cracking, loss of flow or other signs of deterioration, then it is compatible with the fluid.

Pressure

Peristaltic pump applications typically have been limited by the pressure capabilities of the tubing. If the pressure is too high, the tubing could swell, resulting in an improper fit through the pump head, which causes excessive wear and tubing failure. The factors which affect the pressure are material, the proportion of diameter and wall thickness, etc.

Temperature

The working temperature range of a tubing material is another important consideration. Different materials have different temperature range.

Dimension

The size of the tubing has a direct effect on the amount of fluid delivered. Well-designed pumps are engineered to work with an optimum tubing size or range of tubing sizes, taking into account the tubing's inner diameter and wall thickness. The inner diameter determines the amount of fluid delivered with each turn of the rotor. The wall thickness affects the tubing's ability to spring back to its original shape after each compression, which has a great influence on the overall life of the tubing.

Regulatory Approval

Many tubing materials are designed to meet these various regulatory approvals, including those issued by the United States Pharmacopoeia (USP), European Pharmacopoeia (EP), U.S. Food and Drug Administration (FDA), U.S. Department of Agriculture (USDA) and National Sanitation Foundation (NSF).

Tubing Flex Life

Different tubing materials have differing abilities to withstand the repeated squeezing action of the rollers. In general, each tubing size, tubing material, pump head style, and operating speed in combination has its own life characteristics. Service life, or flex life in the pump, is the primary concern in a new applications. Pump performance is very consistent in a specific applications. Maximize the life of a pump system by selecting a tubing material that offers long flex life, using thicker wall tubing, and/or by operating a larger pump at slower speed.

Peristaltic Pump Hose

Common Tubing Material

Silicone tubing: Ultra-smooth inner liner with extremely low leachables, low protein absorption, good flexibility and wide temperature range -51 to 238°C.

Various materials tubings are available.

Tubing Specifications:

Micro & small flow tubing

Tubing Sizes	0.13×0.9	0.51×0.9	0.76×0.85	1.52×0.85	2.06×0.85	3.17×0.85	0.5×0.8	1×1	2×1	2.4×0.8	3×1	
Tubing cross sections (1:1)												
Wall thickness (mm)	0.9			0.85			0.8	1	2	0.8	1	
Inner diameter (mm)	0.13	0.51	0.76	1.52	2.06	3.17	0.5	1	2	2.4	3	
Maximum pressure (Mpa)	Continuous						0.1					
	Intermittent						0.1					

Medium flow tubing

Tubing Sizes	13 [#]	14 [#]	19 [#]	16 [#]	25 [#]	17 [#]	18 [#]	15 [#]	24 [#]	35 [#]	36 [#]	
Tubing cross sections (1:1)												
Wall thickness of domestic tubing (mm)	1.6						2.4					
Wall thickness of imported tubing (inch)	1/16"						3/32"					
Inner diameter of domestic tubing (mm)	0.8	1.6	2.4	3.2	4.8	6.4	7.9	4.8	6.4	7.9	9.6	
Inner diameter of imported tubing (inch)	1/32"	1/16"	3/32"	1/8"	3/16"	1/4"	5/16"	3/16"	1/4"	5/16"	3/8"	
Maximum pressure (Mpa)	Continuous			0.17			0.14		0.10		0.07	
	Intermittent			0.27			0.24		0.14		0.10	

Industrial tubing

Tubing Sizes	73 [#]	82 [#]	88 [#]	92 [#]
Tubing cross sections (1:1)				
Wall thickness of domestic tubing (mm)	3.3		4.8	
Wall thickness of imported tubing (inch)	1/8"		3/16"	
Inner diameter of domestic tubing (mm)	9.6	12.7	12.7	25.4
Inner diameter of imported tubing (inch)	3/8"	1/2"	1/2"	1"
Maximum pressure (Mpa)	Continuous		0.14	
	Intermittent		0.14	

Flow Reference Curve

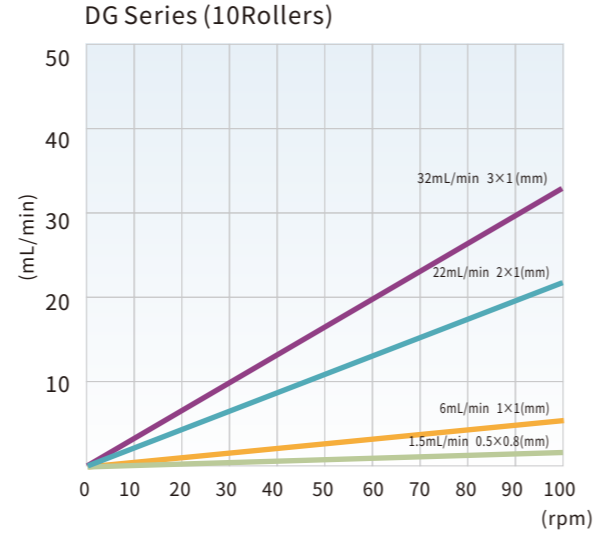
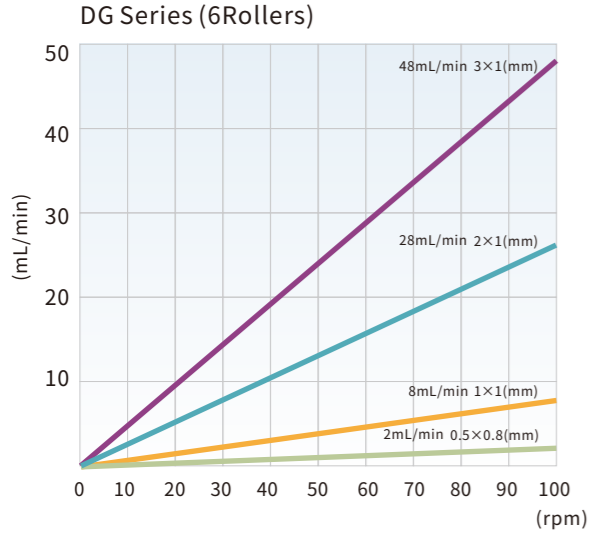

Flow Reference Curve

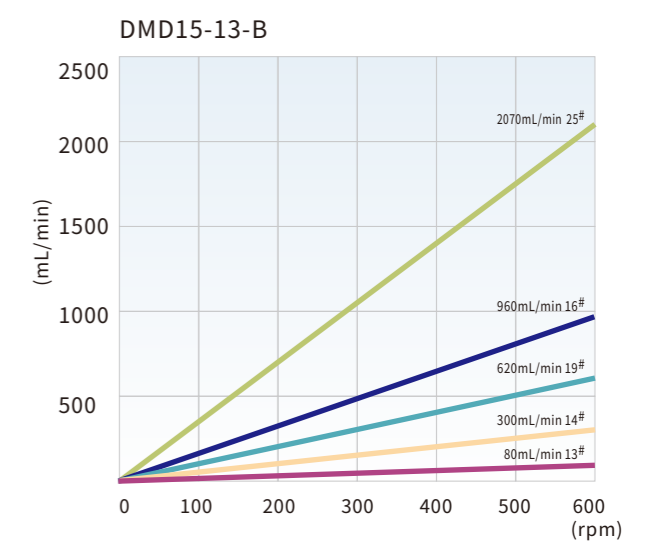
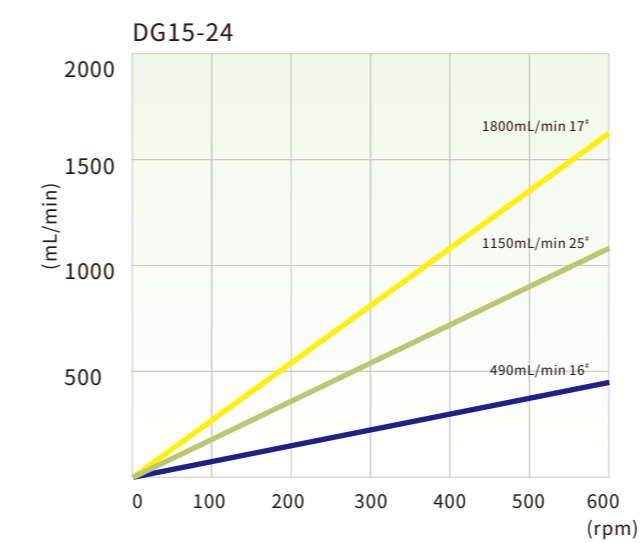
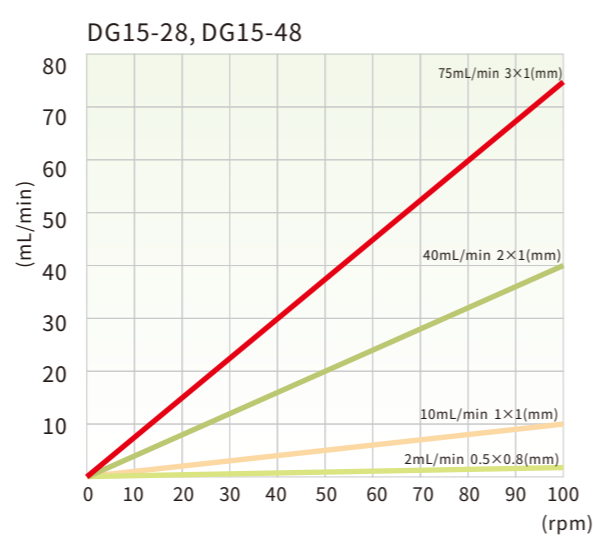
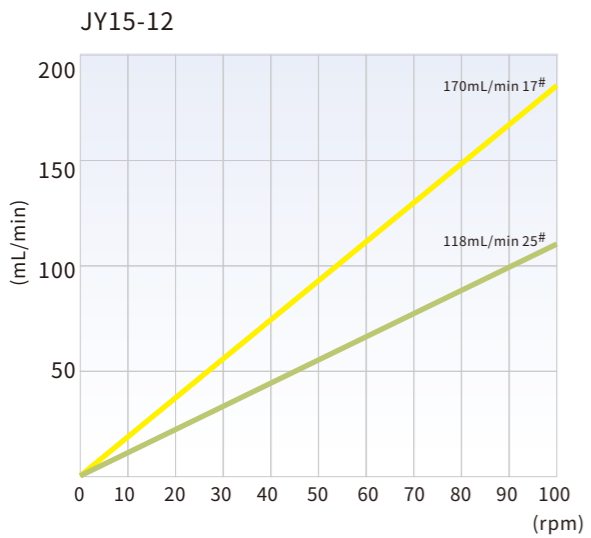
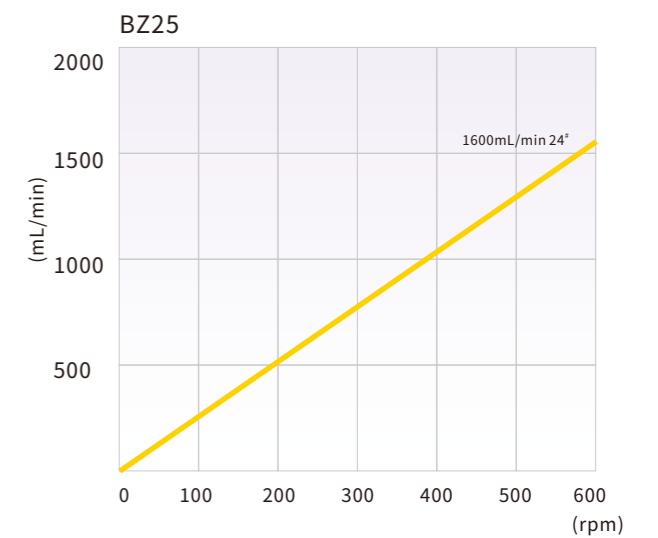
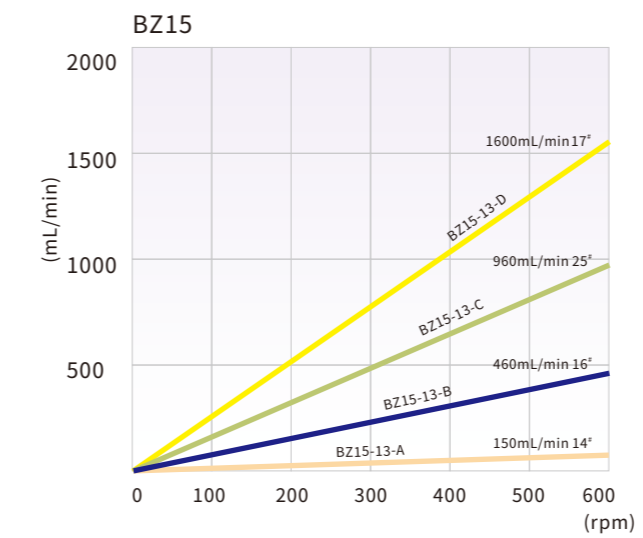
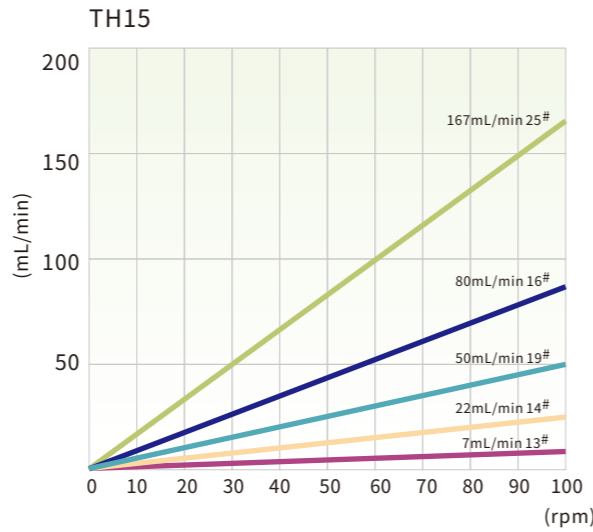
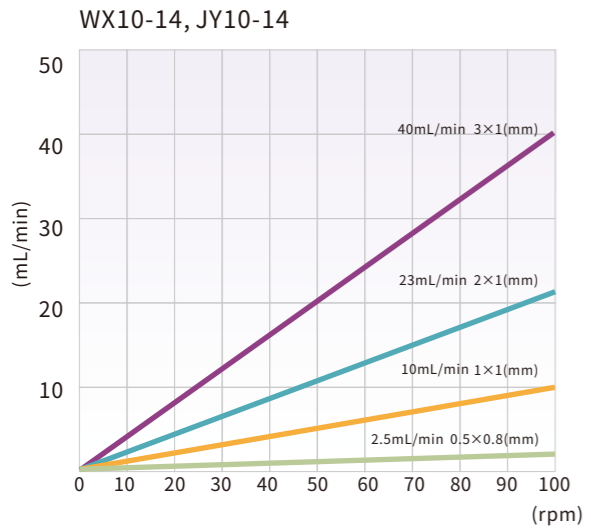
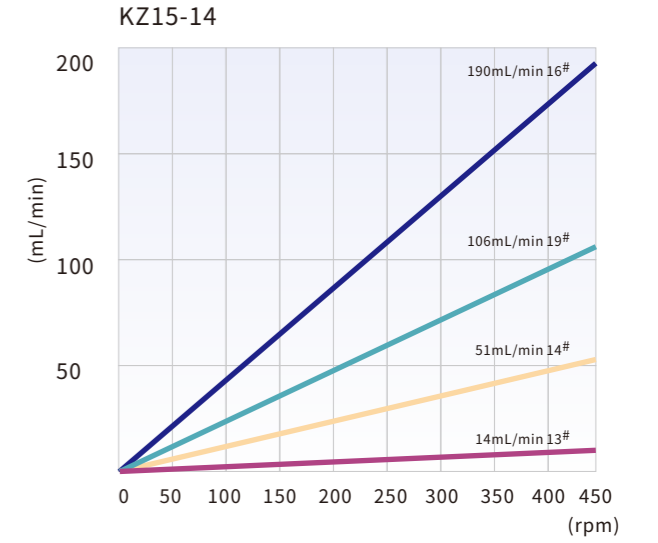
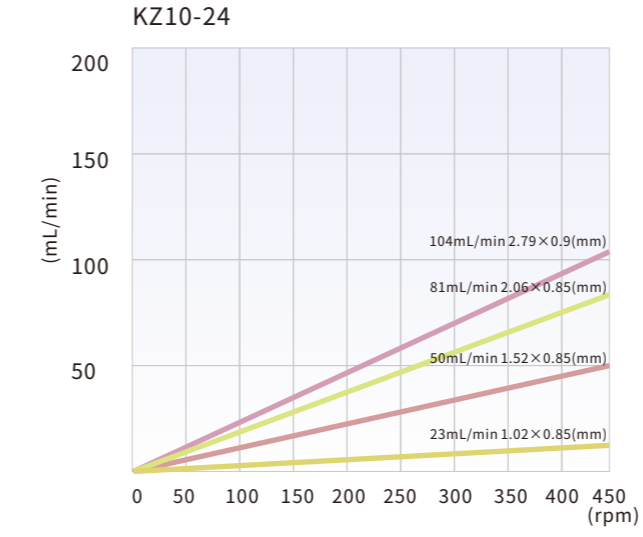

Flow Reference Curve

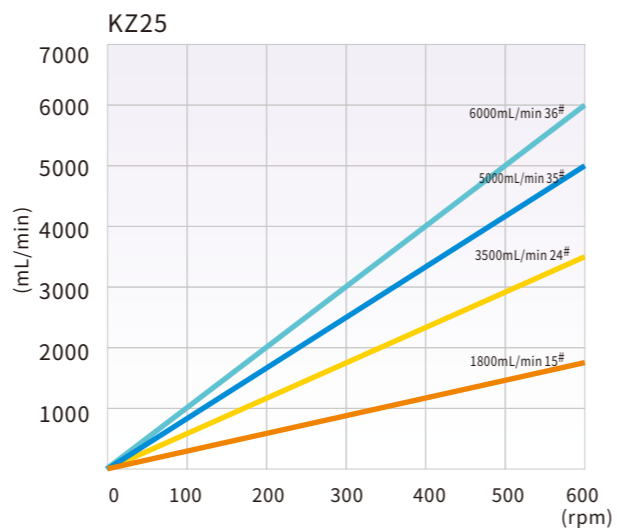
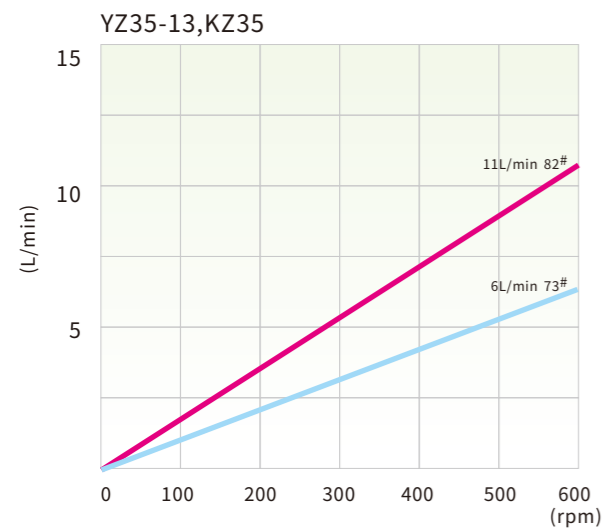
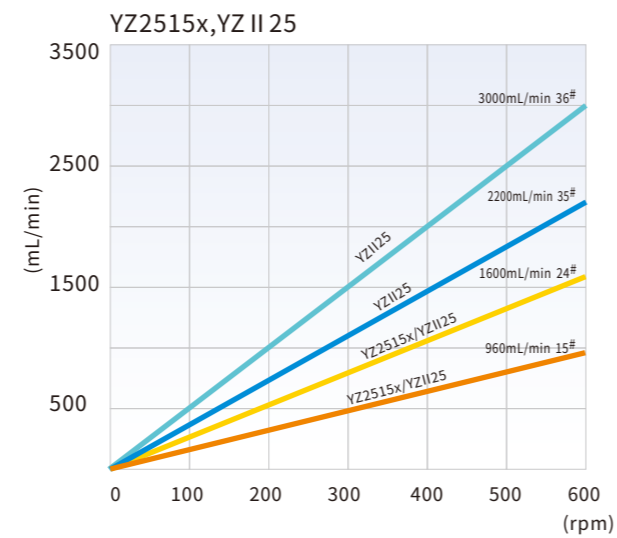
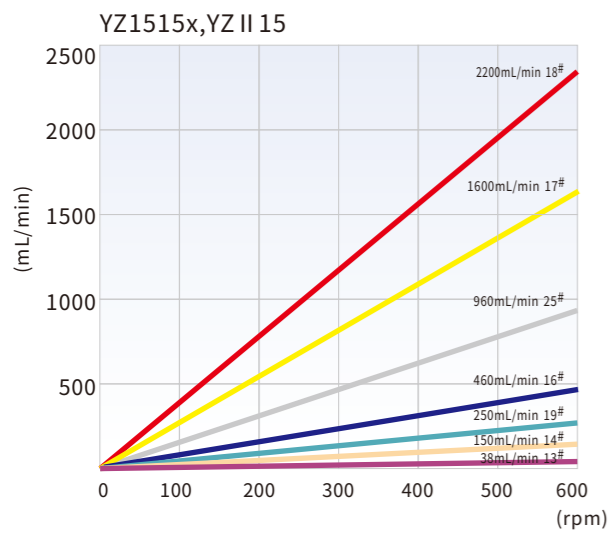
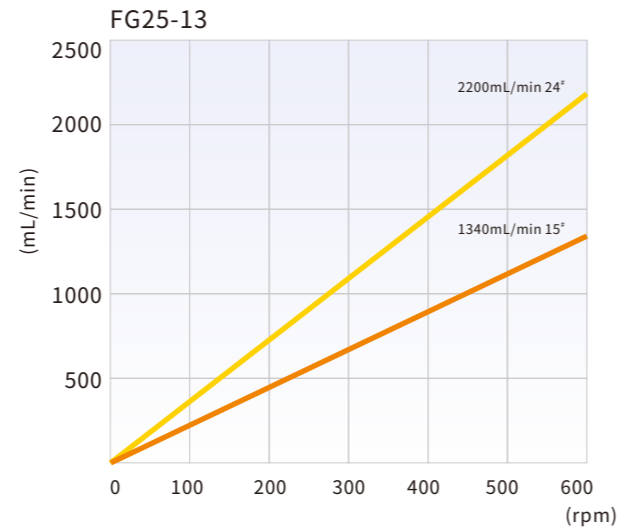
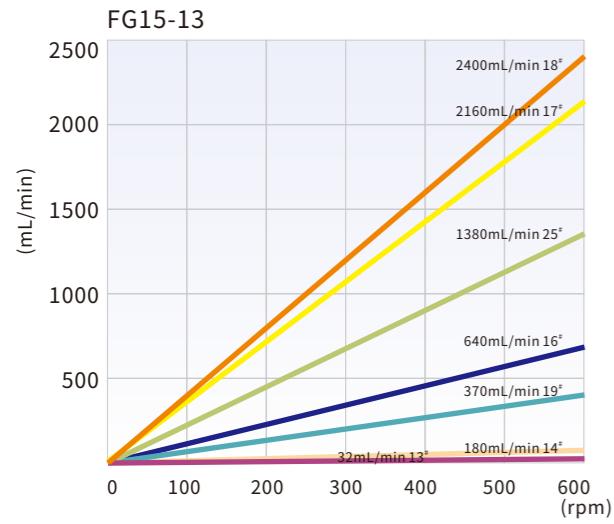

Peristaltic Pump Accessories

Standard External Control Module



Dispensing Controller



Peristaltic pump equipped with dispensing controller has dispensing function.

Dispensing time	0-99.99S
Pause time	0-99.99S
Time resolution	0.01S
Work mode	Single or multiple
Internal count range	0-999, count up or count down
External count range	0-999999, "0" means unlimited cycle
External Start/Stop signal input	Open switch signal
Power-off memory	Return to previous status when powered on
Power supply	AC 220V/5W

Footswitch - JK Series

Multi-work modes and interfaces are available.



Tubing Fitting

Common tubing fitting material:

Natural Polypropylene (Natural PP):
Very good chemical resistance. Temperature range: 0 to 95°C.
Multi-material for tubing fitting are available.

Common tubing fitting type:

Straight, "Y" type, reducing connectors.
There are lots of other tubing fitting type available.

Straight Connector	ID		Tubing				
	(inch)	(mm)					
	1/16"	1.6	13" 14"				
	1/8"	3.2	16"				
	3/16"	4.8	15" 25"				
	1/4"	6.4	17" 24"				
	3/8"	9.6	18" 35" 36" 73" 86"				
	1/2"	12.7	82" 88"				
	3/4"	19	90"				
	1"	25.4	92"				
"Y" Type Connector	ID		Tubing				
	(inch)	(mm)					
		1/16"	1.6	13" 14"			
		1/8"	3.2	16"			
		3/16"	4.8	15" 25"			
1/4"		6.4	17" 24"				
3/8"		9.6	18" 35" 36" 73" 86"				
1/2"	12.7	82" 88"					
Reducing Connector	ID1		ID2		Tubing1	Tubing2	
	(inch)	(mm)	(inch)	(mm)			
		1/16"	1.6	1/8"	3.2	13" 14"	16"
		1/8"	3.2	3/16"	4.8	16"	15" 25"
		1/8"	3.2	1/4"	6.4	16"	17" 24"
		1/4"	6.4	3/8"	9.6	17" 24"	18" 35" 36" 73" 86"
		3/8"	9.6	1/2"	12.7	18" 35" 36" 73" 86"	82" 88"
		1/2"	12.7	3/4"	19	82" 88"	90"
		1/2"	12.7	1"	25.4	82" 88"	92"